

WAVE LINE 2020

HEIGHT SAFETY FITTINGS AND FALL ARREST COMPONENTS

WWW.BLUEWAVE.DK

BLUE WAVE[®]
WIRE DESIGN SYSTEM

Information and contact

You are kindly asked to contact your local Blue Wave dealer/distributor, or Blue Wave direct, should you have questions or need further documentation.

Blue Wave A/S

H.C. Oerstedsvej 2
DK 6100 Haderslev
Denmark

Email:

bluewave@bluewave.dk

Website:

bluewave.dk

Phone:

+ 45 73 22 14 14

BLUE WAVE RIGGING HARDWARE

In business since 1932 Danish based Blue Wave A/S is today among the leading manufacturers of high quality stainless steel rigging hardware. Focus has for years been on Marine, Architectural and Industrial sectors.

By constant development and investments in high tech production machinery, focus on customer needs and wishes, a well known brand name has been established.

Today's product range covers stainless steel wire fittings, ranging from Ø 2 mm to Ø 32 mm wire diameter, although the focus in the Lifeline range here is on Ø 8 mm wire only.

Key factor and future aim, is continued development backed by customer commitment and driven by market demand.

Applying efficient production, good design, low weight and optimal strength to its products Blue Wave strives to become the number one chosen supplier of rigging hardware.

Product information and contact

Manufactured to the highest quality and tested in their design and performance, Blue Wave components are used on buildings and structures around the world.

All products are AISI 316/316L quality and can be used in temperature range from -40°C to +100°C.

You are kindly requested to contact your local Blue Wave dealer/distributor, or Blue Wave direct, should you have any questions or need further documentation.

LIFELINE WIRE FITTINGS

Protecting the safety of individuals working at height with correct wire attachment is critical.

The right attachment/termination onto the wire can only be achieved by firmly pressing the material of the terminal onto the strands of the wire – in this way approx. 90% of the wire Break load will be achieved.

The Blue Wave Lifeline fittings can be divided into three groups of wire attachment.



Please pay attention to the icons contained in this catalogue.

MACHINE SWAGE

- for optimal break load Blue Wave recommends pressing or swaging/rolling the terminals onto the wire ropes.

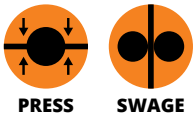

Recommended machines for this purpose are e.g. presses from TALURIT® and roller swaging machines from WIRETEKNIK.

HAND CRIMP FITTINGS

- a range of fittings with outside diameter Ø 13 mm. Can be crimped onto the wires using a hand tool.



Recommended tools for this purpose is e.g. the Dubuis 18V Li-ion battery driven tool. For further information see page 27.



SWAGELESS TERMINALS

- If the exact length of the final wire is unknown or a machine not available, a swageless terminal enables attachment on site.

For further information see page 26.



Batch ID numbers and certificates

on request each product can be marked with serial number.

The product can then be traced back to the specific production batch and raw material.

Declaration of compliance with order, test reports and inspection certificates are made to order on request.

TABLE OF CONTENTS

Blue Wave – Wave Line Catalogue 2020



2
Blue Wave

3
Lifeline wire fittings and certificates

7
Anchor Point Strops

8-10
Machines Swage fitting

12-14
Hand crimp fittings

16-17
Swageless fittings

18-24
Spare parts & components

25
Anchor Point Strops and Wire rope

26
Swageless instruction

27
Machines and tools

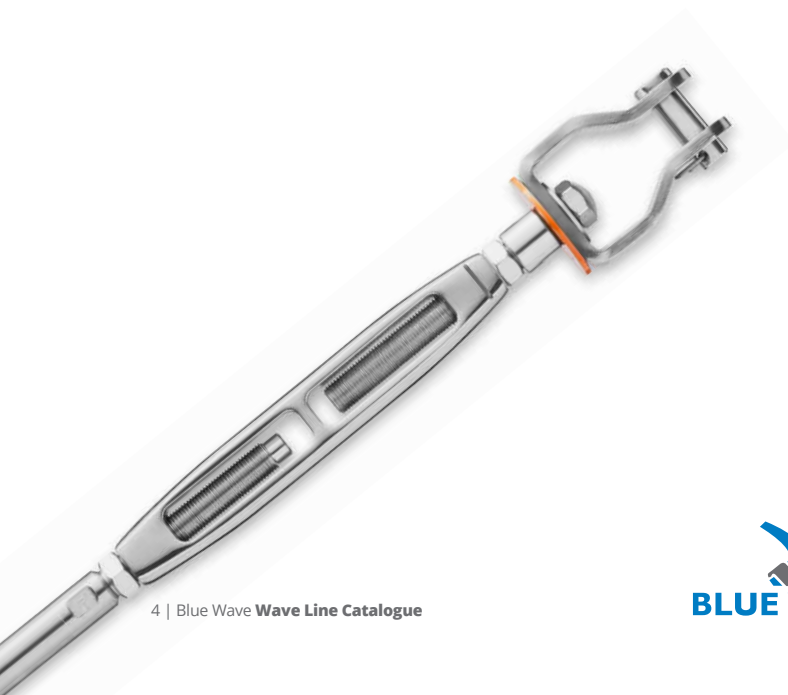







Anchor Point Strops

The anchor point strops are used as first man up system and must be attached to a load rating anchor.

- Flexible Ø 6 mm AISI 316 wire with Quick link and thimble ends.
- 2.000 kg break load
- Standard 1, 2 and 3 meter lengths available.
- Black UV plastic coating to protect roof and user.
- Full Traceability

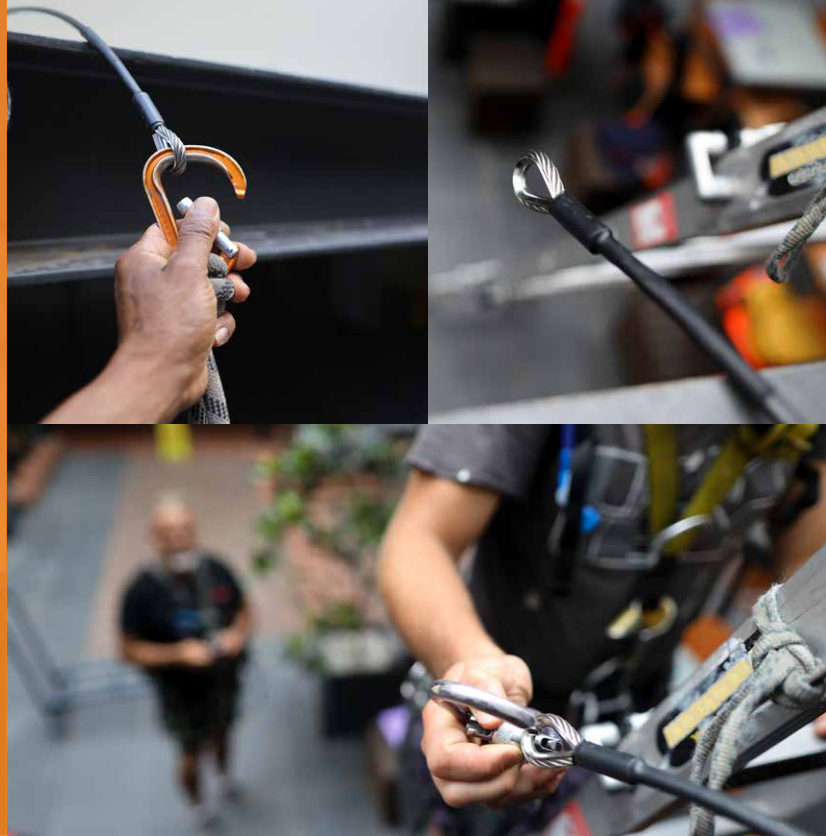

AISI 316 stainless steel coated wire, well suited for use in extreme environments such as hot rooftops as well as contact with:

- sharp edges
- flames or sparks
- With chemicals

Good for use in construction as well as civil works.

Data
page 25



MACHINE SWAGE FITTINGS

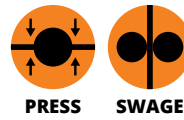

- for optimal break load Blue Wave recommends pressing or swaging/rolling the terminals onto the wire ropes.

RIGGING SCREW FORK/TERMINAL

Electro polished stainless steel AISI 316L

ART. NO.	G	WIRE	PIN	A	B	D	L1	L2	BL/KG	PACK
120812A	1/2"	8	12,7	14	25	16	416	310	6100	5
120812	M12	8	12	14	25	16	416	310	5100	5
120814	M14	8	12	14	25	16	453	333	6800	5
120816AX	5/8"	8	16	18	32	16	499	366	8000	5
120816X	M16	8	16	18	32	16	499	366	8000	5

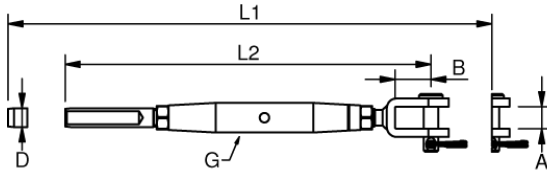

Electro polished stainless steel AISI 316L / Chrome bronze body

ART. NO.	G	WIRE	PIN	A	B	D	L1	L2	BL/KG	PACK
130812AN	1/2"	8	12,7	14	25	16	422	332	6100	5
130816AXN	5/8"	8	16	17	33	16	498	390	8000	5

RIGGING SCREW TOGGLE/TERMINAL

Electro polished stainless steel AISI 316L

ART. NO.	G	WIRE	PIN	A	B	D	L1	L2	BL/KG	PACK
320812AX	1/2"	8	12,7	18	35	16	444	338	6100	5
320812X	M12	8	12,7	18	35	16	440	350	8100	5
320814X	M14	8	12,7	18	35	16	497	383	6900	5
320816AX	5/8"	8	16	20	41	16	533	419	8000	-
320816X	M16	8	16	20	41	16	528	398	8000	-

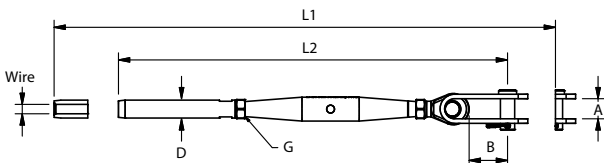

Electro polished stainless steel AISI 316L / Chrome bronze body

ART. NO.	G	WIRE	PIN	A	B	D2	L1	L2	BL/KG	PACK
330812AXN	1/2"	8	12,7	18	35	16	459	367	6100	5
330816AXN	5/8"	8	16	20	40	16	549	439	8000	-



MACHINE SWAGE FITTINGS

RIGGING SCREW TENSION FORK/TERMINAL

Polished stainless steel AISI 316

ART. NO.	G	WIRE	PIN	A	B	D	L1	L2	BL/KG	PACK
130812ATBW	1/2"	8	12	17	43	16	472	378	6100	10

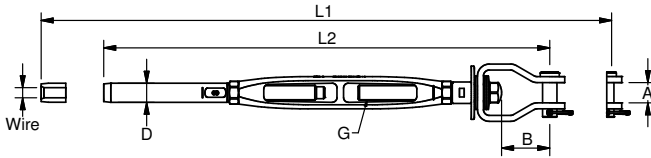

**Calibrated to 800N
Handle with care!**



ART. NO.	G	WIRE	PIN	A	B	D	L1	L2	BL/KG	PACK
120812ATBW	1/2"	8	12	17	43	16	456	364	6100	10

**Calibrated to 800N
Handle with care!**

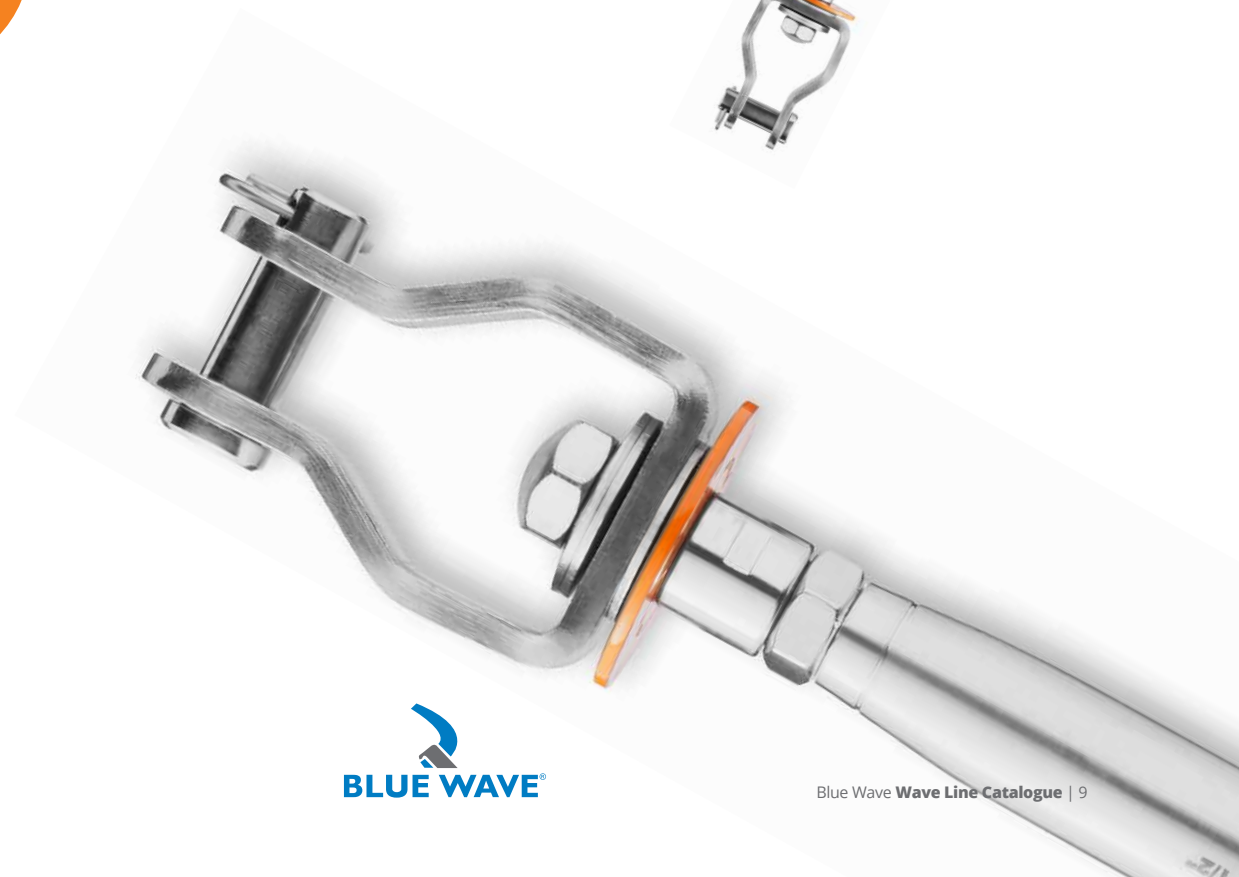

MACHINE SWAGE FITTINGS

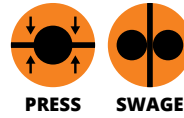

- for optimal break load Blue Wave recommends pressing or swaging/rolling the terminals onto the wire ropes.

TOGGLE TERMINAL

Electro polished stainless steel AISI 316L

ART. NO.	WIRE	PIN	A	B	D2	L1	L2	L3	BL/KG	PACK
501308	8	12,7	18	33	16	170	83	30	6200	5
501608X	8	16	20	41	16	198	83	35	9800	5

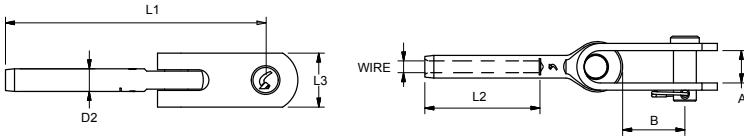

THREAD TERMINAL

Electro polished stainless steel AISI 316L

ART. NO.	ART. NO. L	G	WIRE	D	L1	L2	L3	BL/KG	PACK
900812A	910812A	1/2"	8	16	185	80	83	6100	-
900812	910812	M12	8	16	185	80	83	5100	-
900814	910814	M14	8	16	194	83	89	6900	-
900816A	910816A	5/8"	8	16	203	83	100	8700	-
900816	910816	M16	8	16	203	83	100	8700	-

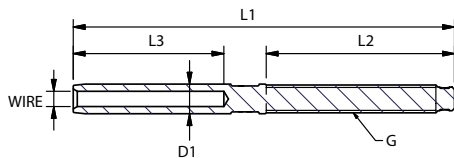

FORK TERMINAL

Electro polished stainless steel AISI 316L

ART. NO.	WIRE	PIN	A	B	D	L1	L2	BL/KG	PACK
101208	8	12	14	25	16	136	83	6500	10
101408	8	14	18	33	16	143	83	8000	10
101608	8	16	18	33	16	145	83	8500	10

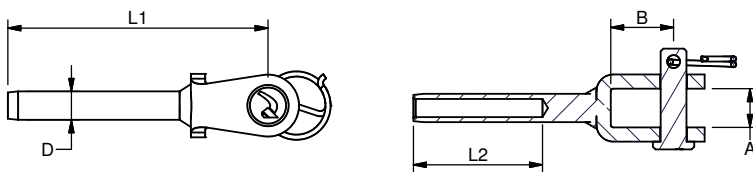

EYE TERMINAL

Electro polished stainless steel AISI 316L

ART. NO.	WIRE	T	B	D1	D2	L1	L2	BL/KG	PACK
190008	8	10	30	16	14,5	124	83	8700	10
190008X	8	12	36	16	16,5	141	83	8700	10

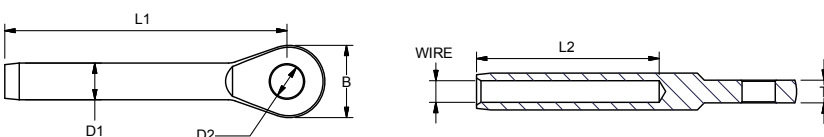



HAND CRIMP FITTINGS



A range of fittings with outside diameter \varnothing 13 mm. Can be crimped onto the wires using a hand tool.

RIGGING SCREW FORK/TERMINAL

Electro polished stainless steel AISI 316L

ART. NO.	G	WIRE	PIN	A	B	D	L1	L2	BL/KG	PACK
126812A	1/2"	8	12,7	14	25	13	404	316	4600	10
126812	M12	8	12	14	25	13	416	316	4600	10

Note:  On request - also available with open body.

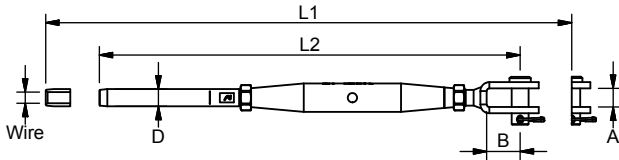

RIGGING SCREW TOGGLE/TERMINAL

Electro polished stainless steel AISI 316L

ART. NO.	G	WIRE	PIN	A	B	D2	L1	L2	B.L.	PACK
320812AD	1/2"	8	12,7	18	35	13	442	348	4600	10
32081213	M12	8	12	18	35	13	458	348	4600	10

Note:  On request - Also available with open body.:

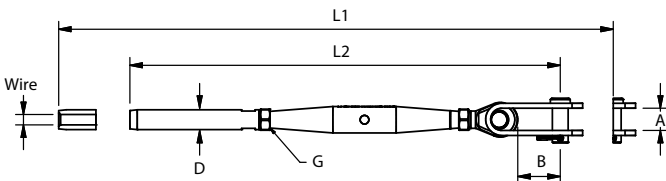

RIGGING SCREW TENSION FORK/TERMINAL

Electro polished stainless steel AISI 316L

ART. NO.	G	WIRE	PIN	A	B	D	L1	L2	BL/KG	PACK
SS1308ATBW	1/2"	8	12	17	43	13	472	378	4600	10

Note:  On request - also available with open body.

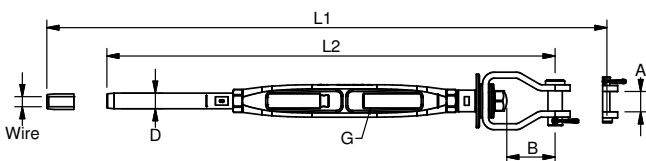

Calibrated to 800N
Handle with care!



HAND CRIMP FITTINGS



A range of fittings with outside diameter \varnothing 13 mm. Can be crimped onto the wires using a hand tool.

TOGGLE TERMINAL

Electro polished stainless steel AISI 316L

ART. NO.	WIRE	PIN	A	B	D	L1	L2	L3	BL/KG	PACK
501208D	8	12,7	18	34	13	173	83	80	4600	-

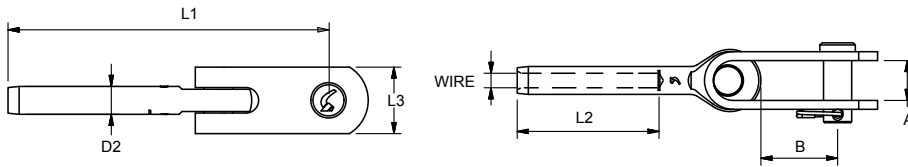

THREAD TERMINAL

Electro polished stainless steel AISI 316L

ART. NO.	ART. NO. L	G	WIRE	D	L1	L2	L3	BL/KG	PACK
930812D	940812D	1/2"	8	13	185	80	83	4600	-
90081213	91081213	M12	8	13	185	80	83	4600	-

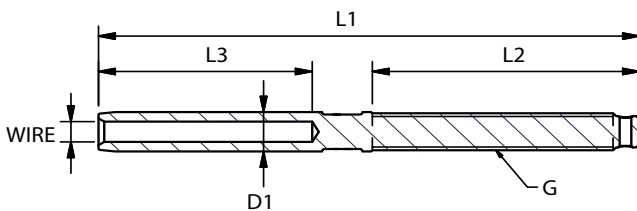

HAND CRIMP FITTINGS



A range of fittings with outside diameter \varnothing 13 mm. Can be crimped onto the wires using a hand tool.

DOUBLE TERMINAL

Electro polished stainless steel AISI 316L

ART. NO.	WIRE	D	L1	L2	BL/KG	PACK
90080813G	8	13	190	80	4600	10

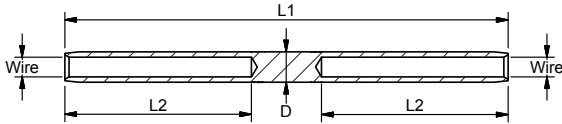

FORK TERMINAL

Electro polished stainless steel AISI 316L

ART. NO.	WIRE	PIN	A	B	D	L1	L2	BL/KG	PACK
101208D	8	12	14	25	13	136	83	4600	10

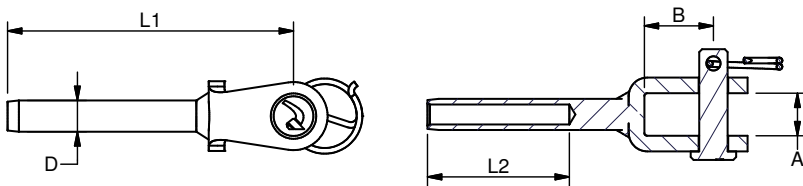

EYE TERMINAL

Electro polished stainless steel AISI 316L

ART. NO.	WIRE	D1	T	B	D2	L1	L2	BL/KG	PACK
190008D	8	13	10	30	14,5	123,5	83	4600	10

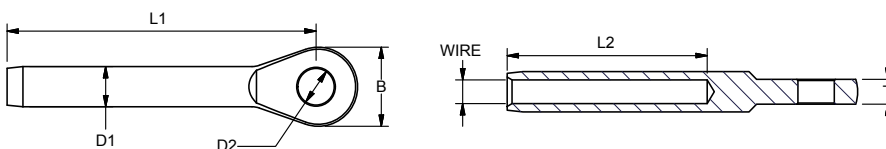



SWAGELESS FITTINGS



SCREW

If the exact length of the final wire is unknown or a machine not available, a swageless terminal enables attachment on site.

All swageless items are on request also available with jaws for 1x19 wire construction.

RIGGING SCREW SWAGELESS FORK/TERMINAL

Electro polished stainless steel AISI 316L, suits 7x7 and 7x19 wire construction

ART. NO.	G	WIRE	PIN	A	B	KW1	KW2	L1	L2	BL/KG	PACK
SS128012A	1/2"	8	12,7	14	25	19	24	379	291	5600	10
SS120812	M12	8	12	14	25	19	24	396	296	5600	10

Note:  On request - also available with open body.

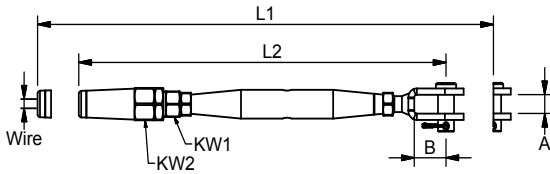

RIGGING SCREW SWAGELESS TOGGLE/TERMINAL

Electro polished stainless steel AISI 316L, suits 7x7 and 7x19 wire construction

ART. NO.	G	WIRE	PIN	A	B	KW1	KW2	L1	L2	BL/KG	PACK
SS870812A	1/2"	8	12,7	18	35	19	24	404	326	5600	10

Note:  On request - also available with open body.

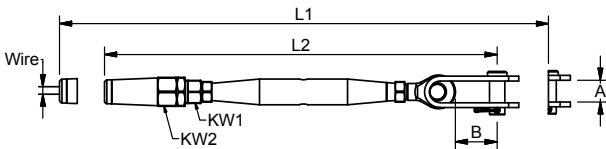

RIGGING SCREW SWAGELESS TENSION FORK/TERMINAL

Electro polished stainless steel AISI 316L, suits 7x7 and 7x19 wire construction

ART. NO.	G	WIRE	PIN	A	B	KW1	KW2	L1	L2	BL/KG	PACK
SS8608ATBW	1/2"	8	12	17	43	19	24	355	447	5600	10

Note:  On request - also available with closed body.

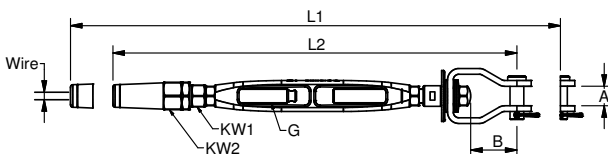

Calibrated to 800N
Handle with care!



SWAGELESS FITTINGS



SCREW

If the exact length of the final wire is unknown or a machine not available, a swageless terminal enables attachment on site.

All swageless items are on request also available with jaws for 1x19 wire construction.

SWAGELESS TOGGLE TERMINAL

Electro polished stainless steel AISI 316L, suits 7x7 and 7x19 wire construction

ART. NO.	WIRE	PIN	A	B	KW1	KW2	L1	L2	L3	BL/KG	PACK
831208SS	8	12,7	18	30	24	19	148	102	30	5600	5

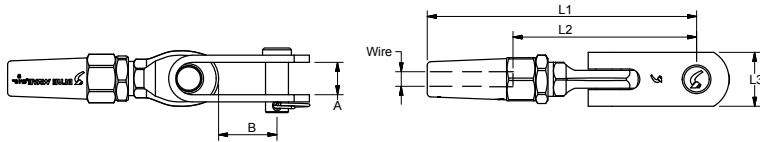

SWAGELESS THREAD TERMINAL

Electro polished stainless steel AISI 316L, suits 7x7 and 7x19 wire construction

ART. NO. R	ART. NO. L	G	WIRE	KW1	KW2	L1	L2	L3	BL/KG	PACK
800812ASS	810812ASS	1/2"	8	19	24	162	107	80	5600	-
800812SS	810812SS	M12	8	19	24	162	107	80	5100	-
800814SS	810814SS	M14	8	19	24	171	122	89	5600	-
800816ASS	810816ASS	5/8"	8	19	24	182	133	100	5600	-
800816SS	810816SS	M16	8	24	27	190	139	100	5600	-

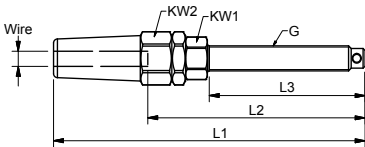

SWAGELESS FORK TERMINAL

Electro polished stainless steel AISI 316L, suits 7x7 and 7x19 wire construction

ART. NO.	WIRE	PIN	A	B	KW1	KW2	L1	L2	L3	BL/KG	PACK
841208SS	8	12	14	21	24	58	103	118	58	5600	5
841408SS	8	14	14	21	24	58	103	118	58	5600	5

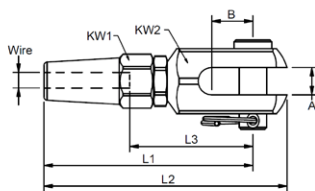

SWAGELESS EYE TERMINAL

Electro polished stainless steel AISI 316L, suits 7x7 and 7x19 wire construction

ART. NO.	WIRE	T	KW1	KW2	D	L1	L2	L3	BL/KG	PACK
821908SS	8	10	19	24	14,5	121	103	52,5	5600	5

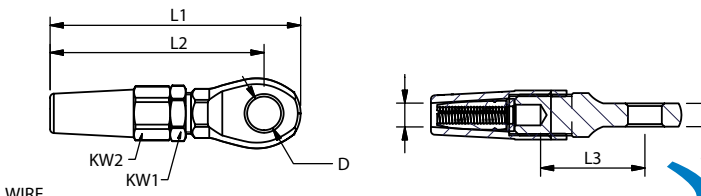

SPARE PARTS & COMPONENTS

RIGGING SCREW FORK/FORK

Electro polished stainless steel AISI 316L

ART. NO.	G	PIN	A	B	L1	L2	BL/KG	PACK
120012A	1/2"	12,7	14	25	350	244	6100	5
120012	M12	12	14	25	350	244	5100	5
120014X	M14	14	18	32	405	295	6900	5
120016X	M16	16	18	33	446	313	9400	5

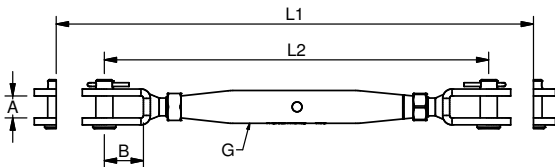

RIGGING SCREW TENSION FORK / FORK

Electro polished stainless steel AISI 316L

ART. NO.	G	PIN1	PIN2	A1	A2	B1	B2	L1	L2	BL/KG	PACK
SS1300ATBW	1/2"	12	12,7	17	14	43	25	406	318	6100	10

Note:  On request - also available with closed body.

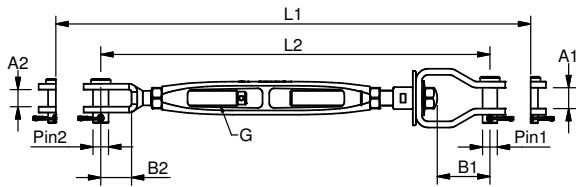

Calibrated to 800N
Handle with care!



RIGGING SCREW LH FORK/BLANK

Electro polished stainless steel AISI 316L

ART. NO.	G	PIN	A	B	L1	L2	BL/KG	PACK
120012S	M12	12	14	25	252	202	5100	5
120012AS	1/2"	12,7	14	25	246	202	6100	6

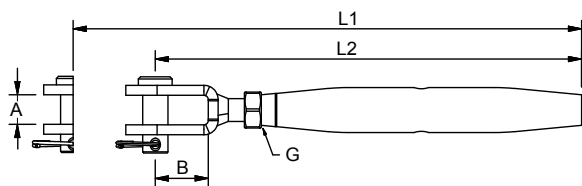

SPARE PARTS & COMPONENTS

BODY

Chromed, Bronze or stainless steel AISI 316

ART. NO.	G	D	L	KW	MAT.	BL/KG	PACK
SS011312A	1/2"	27	170	17,4	SS	6100	10
SS011312	M12	27	170	17,4	SS	5100	10
011312A	1/2"	27	170	17,4	BR	6100	10
011312	M12	27	170	17,4	BR	5100	10
011316A	5/8"	32	210	20,7	BR	9900	5

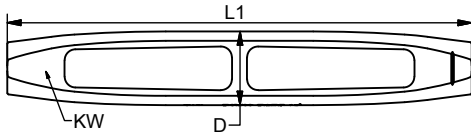

BODY

Electro polished stainless steel AISI 316L

ART. NO.	G	D	Ø	L	BL/KG	PACK
011212	M12	21	7	152	5100	10
011212A	1/2"	21	7	152	6100	10
011216	M16	27	8	190	9400	10
011216A	5/8"	27	8	190	9900	10

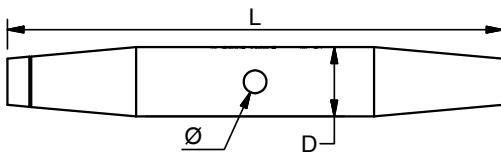

SPARE PARTS & COMPONENTS

THREAD TOGGLE

Electro polished stainless steel AISI 316L

ART. NO. R	ART. NO. L	G	PIN	A	B	L1	L2	L3	BL/KG	PACK
023212AXB	033212AXB	1/2"	12,7	18	35	155	80	30	6100	-
023212XB	033212XB	M12	12,7	18	34	155	80	30	5100	-
023214B	033214B	M14	12,7	18	33	172	90	30	6900	-
023216AXB	033216AXB	5/8"	16	20	41	199	100	35	9900	-
023216XB	033216XB	M16	16	20	41	199	100	35	9400	-

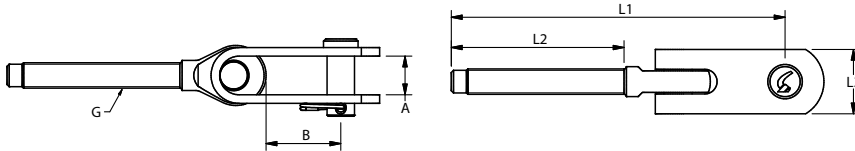

THREAD TERMINAL

Electro polished stainless steel AISI 316L



Note: For details please see tables pages 10 and 13



THREAD FORK

Electro polished stainless steel AISI 316L

ART. NO. R	ART. NO. L	G	PIN	A	B	L1	L2	BL/KG	PACK
021212AB	031212AB	1/2"	12,7	14	25	119	80	6100	-
021212B	031212B	M12	12	14	25	119	80	5000	-
021212XB	031212XB	M12	12	18	33	129	80	5000	-
021214B	031214B	M14	12	18	25	137	90	6900	-
021216AB	031216AB	5/8"	16	20	41	199	100	9900	-
021216B	031216B	M16	14	18	33	151	100	9400	-

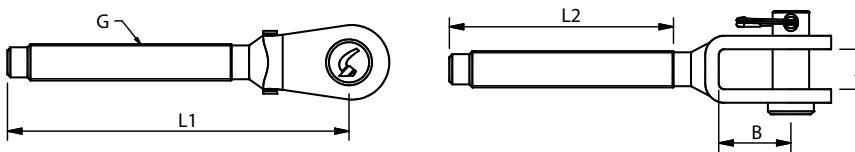

TENSION FORK

Electro polished stainless steel AISI 316L

ART. NO.	G	A	B	L1	L2	BL/KG	PACK
0312ATFBW	1/2"	17	43	163	84	6100	10

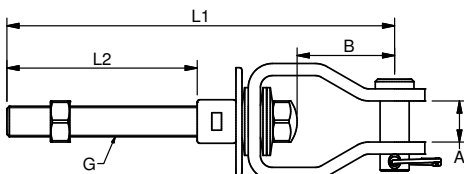

Calibrated to 800N
Handle with care!





SPARE PARTS & COMPONENTS

TENSION FORK WITH EYE

Electro polished stainless steel AISI 316L

ART. NO.	T	PIN	L1	D	B	A	B.L.	PACK
021912ATBW	12	12	124	13	43	17	6100	10

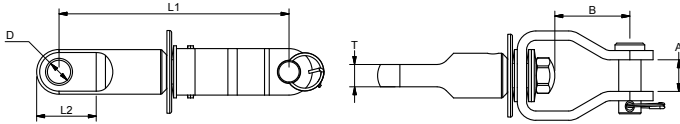

Calibrated to 800N
Handle with care!



THREAD EYE

Electro polished stainless steel AISI 316L

ART. NO. R	ART. NO. L	G	T	D1	D2	L1	L2	BL/KG	PACK
021912A	031912A	1/2"	10	13,2	28	105	80	6100	10
021912	031912	M12	8	13	25	110	80	5100	10
021914	031914	M14	9	13	28	124	90	6800	10
021916A	031916A	5/8"	10	14,5	31	134	100	9900	10
021916	031916	M16	10	14,5	31	133	100	9400	10

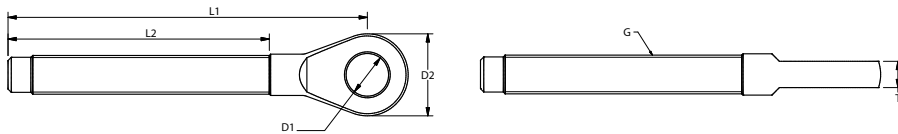

FORGED EYE BOLTS

Polished stainless steel AISI 316

ART. NO.	G	B	D1	D2	L1	L2	L3	BL/KG	KG/100	PACK
3512L	M12	10	30	24	100	136	160	5100	20,9	10
3512XL	M12	11,5	30	29	120	146	172	5100	23,3	10
3516L	M16	12	35	28	100	142	172	7000	36,6	10
3516XL	M16	12	35	28	130	173	202	7000	40,4	10

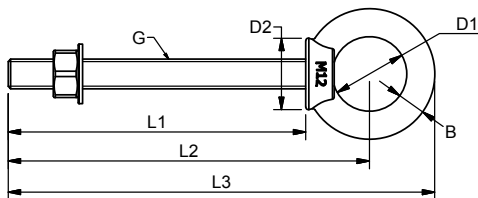

SPARE PARTS & COMPONENTS

FORGED FEMALE - AND MALE NUTS

Electro polished stainless steel AISI 316L

ART. NO.	G	B	D1	D2	L1	L2	BL/KG	KG/100	PACK
983516	M16	14	35	39	32	64	9400	24,9	10

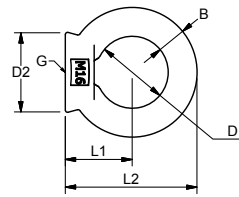

ART. NO.	G	B	D1	D2	L1	L2	L3	BL/KG	KG/100	PACK
3516K	M16	13	35	39	28	62	92	7000	28,6	10

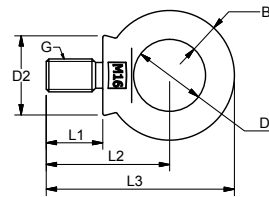

NUTS

Electro polished stainless steel AISI 316L

ART. NO. R	ART. NO. L	G	KW	B	PACK
041212A	051212A	1/2"	17	8	-
041212	051212	M12	17	8	-
041214	051214	M14	19	10	-
041216A	051216A	5/8"	22	11	-
041216	051216	M16	22	11	-

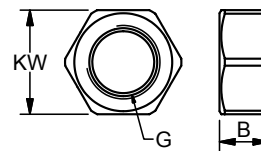

PINS

Electro polished stainless steel AISI 316L

ART. NO.	D1	D2	L	PACK
062812	12	4	28	-
062813	12,7	4	28	-
063214	14	4	33	-
063416	16	8,5	34	-

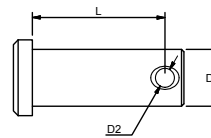

G-RINGS

Electro polished stainless steel AISI 316L

ART. NO.	D1	D2	PACK
070603	1,5	19	100
070604	2	23	100

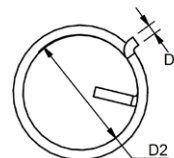

SPLIT PINS

Electro polished stainless steel AISI 316L

ART. NO.	D	L	PACK
070613	3	25	100
0706131	3,2	20	100

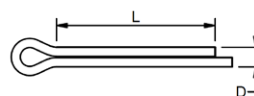

SPARE PARTS & COMPONENTS

THIMBLE

Electro polished stainless steel AISI 316L

ART. NO.	A	A1	B	L	S	KG/100	PACK
110007	8	11	19	33	1,5	1,4	100
110008	9	13,5	22	38	2	2,6	50

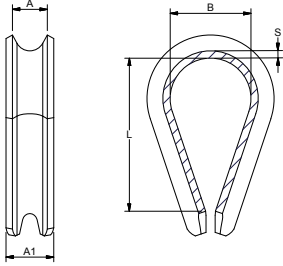

QUICK LINK

Stainless steel AISI 316

ART. NO.	L1	L2	L3	L4	BL/KG	KG/100	PACK
200608	47	15	6	8	2200	3,5	10
200810	58	19	8	10	3500	7,7	10
200810L	72	19	8	18	3500	9	10
201012	71	22	10	12	4500	13,6	10

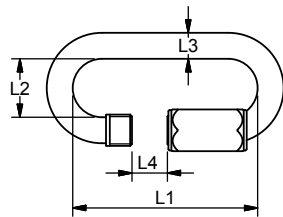

TALURIT

Copper

ART. NO.	L1	L2	L3	D	KG/100	PACK
TAL0828	28	24	16	9	4,6	10

Table for TCU ferrule after pressing.

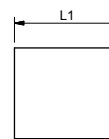

Ferrule No.	Wire Rope Capacity Diameter (mm)				Die Identification		
	Fill factor (f=0,40-0,50) Fibre Core		Fill factor (f=0,50-0,60) Fibre Core		Dies marked	Diameter after pressing	Required pressure approx.
TAL0828	Min	Max	Min	Max	T	mm	kN
8	7,2	8,2	6,7	7,5	8	16	410

f = Fill factor, is the ratio between the sum of the nominal metallic cross-sectional areas of all the wires in the rope and the circumscribed area of the rope based on its nominal diameter.

C = Nominal metallic cross-sectional area factor of the rope.

$$C = \frac{f \cdot \Pi}{4}$$



ANCHOR POINT STROPS

ANCHOR POINT STROPS W. QUICK LINK

6 mm AISI 316 Stainless steel wire

ART. NO.	L	CONST.	DIM	COATED	HEAT SHRINK
STROP61	1m	7x19	6 mm	NO	NO
STROP62	2m	7x19	6 mm	NO	NO
STROP63	3m	7x19	6 mm	NO	NO
STROP611	1m	7x19	6 mm	8 mm	NO
STROP621	2m	7x19	6 mm	8 mm	NO
STROP631	3m	7x19	6 mm	8 mm	NO
STROP6211	1m	7x19	6 mm	8 mm	YES
STROP622	2m	7x19	6 mm	8 mm	YES
STROP623	3m	7x19	6 mm	8 mm	YES



The anchor point stropps are used as first man up system and must be attached to a load rating anchor.

- Flexible Ø 6 mm AISI 316 wire with Quick link and thimble ends.
- 2.000 kg break load
- Standard 1, 2 and 3 meter lengths available.
- Full Traceability

WIRE ROPE

Stainless steel AISI 316

ART. NO.	Ø	CONST.	LENGHT
WR719081	8	7x19	125m
WR719082	8	7x19	250m
WR719083	8	7x19	500m

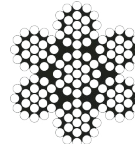

ART. NO.	Ø	CONST.	LENGHT
WR707081	8	7x7	125m
WR707082	8	7x7	250m
WR707083	8	7x7	500m



ART. NO.	Ø	CONST.	LENGHT
WR119081	8	1x19	125m
WR119082	8	1x19	250m
WR119083	8	1x19	500m

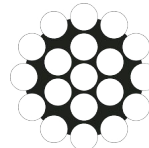



SWAGELESS INSTRUCTION

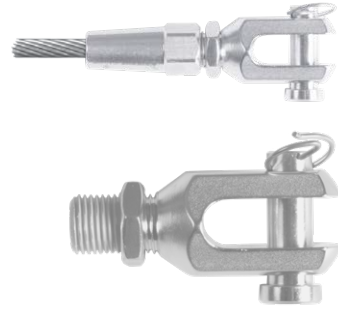

Jaw housing



Jaw housing



Pressure ring (brass)

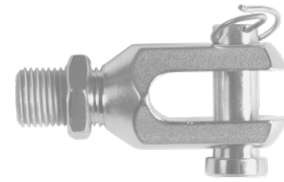

Head

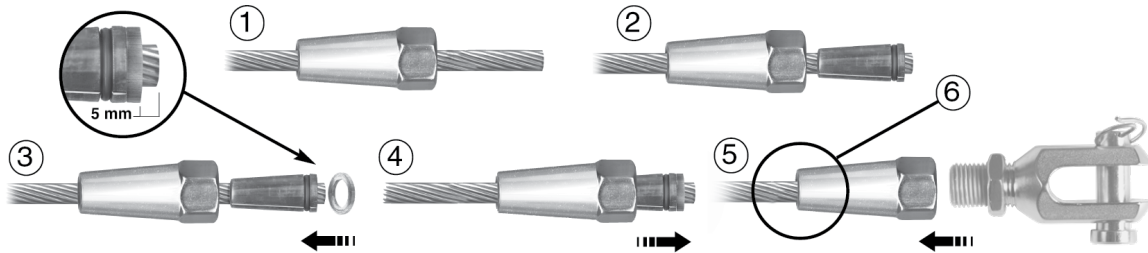

- 1:** First slide the jaw housing in place on the cable.
- 2:** Then slide the jaws onto the cable, ensuring there is some space between the jaw section.
- 3:** Place the brass pressure ring on the end of the cable. Make sure that the distance from the pressure ring to the end of the cable is 5 mm.
- 4:** Slide the jaw housing over the jaws.
- 5:** The terminal can now be assembled. Screw the head firmly on the jaw housing with a spanner. Then tighten the lock nut firmly with a spanner.
- 6:** Do not reuse the jaws. Make sure that the dimensions of the terminal and cable match.



Note

After the first dynamic load the terminal MUST be tightened again. The terminal is developed for use with the following types of cable: 7x19 and 7x7. When assembling Swageless Terminals the breaking strength of the cable used will be reduced by 0-15%. Refer to the table for the breaking strength of the terminal.

Swageless Terminal Breaking strength:

Wire Dim		Breaking Strength	
8,0 mm	5/16"	54,5 KN	12,300 LBS

Tightening torque for Swageless Terminals

Wire Dim		Nm	Lbf ft
8,0 mm	5/16"	58	43.0



On request also available with jaws for 1x19 wire construction

MACHINES AND TOOLS

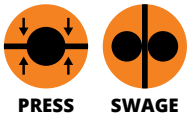

MACHINES FOR MACHINE SWAGE FITTINGS

WIRETEKNIK ROLLER SWAGING MACHINE

Machine including 8 mm die

ART. NO.	DESCRIPTION
WTA200	With hand pump
WTA200PUH1	With PUH1 power unit, instead of hand pump
WTA200230V	Ready to use 230 V
WTA200400V	Ready to use 400 V
WTA20008	Extra roller die 8 mm



TALURIT PRESS, 150T

Machine including 8 mm die

ART. NO.	DESCRIPTION
TAL150	150 ton swager body, needs hydraulic unit
TALHY3KW	Hydraulic unit 3,0 KW
TALHY4KW	Hydraulic unit 4,0 KW
TALHY55KW	Hydraulic unit 5,5 KW
TALHX08	Extra die 8 mm



CRIMP

DUBUIS, 18V

ART. NO.	DESCRIPTION
DUBACC	Complete tool, incl. Battery and die
DUBBAT	Extra battery
DUB05D	extra 8 mm die



WIRE CUTTER

Cuts up to $\varnothing 12$ mm cable

650 mm/2,8 kg

ART. NO.
ARCTOOL7



www.bluewave.dk

Blue Wave reserves the right without notification, to change specifications and descriptions contained in the Wave Line Catalogue. 2020 - 1. ed.