



I-SYS®

EDELSTAHL-SEILSYSTEM

STAINLESS STEEL WIRE ROPE SYSTEM



CARL STAHL ARCHITEKTUR

Geländerfüllungen, Absturzsicherungen, architektonische Lichtinstallationen oder komplexe Zooanlagen: CARL STAHL ARCHITEKTUR realisiert nahezu jede mögliche Anwendung mit Edelstahlseilen und -netzen. Bereits seit 1880 dreht sich bei Carl Stahl alles um das Thema Seil – zu Anfang in Form von Naturfaserseilen für die Landwirtschaft, heutzutage mit Drahtseilen und Hebezeugen zum Fördern schwerster Lasten. In den 1990er Jahren ging daraus unter dem Dach des Traditionskonzerns der Unternehmensbereich „Architektur“ hervor.











Von der Beratung und Planung über die statische Berechnung und die Herstellung bis hin zur Montage bietet CARL STAHL ARCHITEKTUR seinen Kunden alles, was sie zur Verwirklichung kreativer Ideen mit Seilen, Netzen und Edelstahl-Systemkomponenten benötigen. Und dies weltweit.

CARL STAHL ARCHITECTURE

From balustrade in-fills and fall protections to architectural lighting installations and complex zoo solutions: CARL STAHL ARCHITECTURE is a specialist for almost any application involving stainless steel cables and mesh. Ever since 1880, Carl Stahl has been up among the leaders when it comes to ropes and cables – originally in the form of natural fibre ropes for agriculture and today as a supplier of steel cables and lifting equipment for very heavy loads. Carl Stahl's "Architecture" division was established in the nineties under the umbrella of its tradition-steeped parent.

From consulting and planning through structural calculations to manufacturing and installation, CARL STAHL ARCHITECTURE provides end-to-end services to customers seeking to realise creative ideas with the help of ropes and cables, meshes and stainless steel system components – no matter where they are in the world.

INHALT_CONTENT

	Basis Informationen Basics	04–05
	Außengewinde External threads	06–19
	Innengewinde Internal threads	20–27
	Gabeln Forks	28–41
	Ösen Eyes	42–53
	Endhülsen End stops	54–63
	Seile, Schlaufen, Klemmen Cables, loops, clamps	64–77
	Zubehör und Hilfsmittel Accessories and auxiliary material	78–93
	Zulassungen Approvals	94–101
	Fassadenbegrünung Green wall systems	102–115
	Materialeigenschaften und Konfektionslängen Material characteristics and assembly lengths	116–118

SYSTEM DER UNBEGRENZTEN MÖGLICHKEITEN

ONE SYSTEM, UNLIMITED OPTIONS

I-SYS umfasst Einzelteile, Kombinationen und individuelle Anwendungen. Vor allem ist I-SYS ein Angebot zur Zusammenarbeit. Die Experten von CARL STAHL ARCHITEKTUR beraten und planen kleine und große Projekte, sie inspirieren zur schönsten Lösung und liefern statische Berechnungen. Ein Service, der ebenso schnell wie professionell erfolgt und weltweit gefragt ist. Von der ersten Idee, der ausgefallenen Entwicklung bis hin zur Fertigung, Montage und zur anschließenden Betreuung reicht das Spektrum der Spezialisten.

I-SYS includes components, combinations and individual applications. Above all, I-SYS constitutes an invitation to cooperative action. The experts from CARL STAHL ARCHITEKTUR offer advice and plan small and large projects, they inspire architects to find the most aesthetically satisfying solutions and supply statical calculations. A service which is as rapid as it is professional and which is in demand all over the world. The range of expertise of our specialists ranges from the first idea, through truly exceptional development, up to manufacture, assembly and subsequent service.



Zulassung_Approval



Selbstmontage_Self-assembly



Begrünung_Greenery

Sk Seilkonstruktion_Rope construction

kl Konfektionslänge_Assembly length

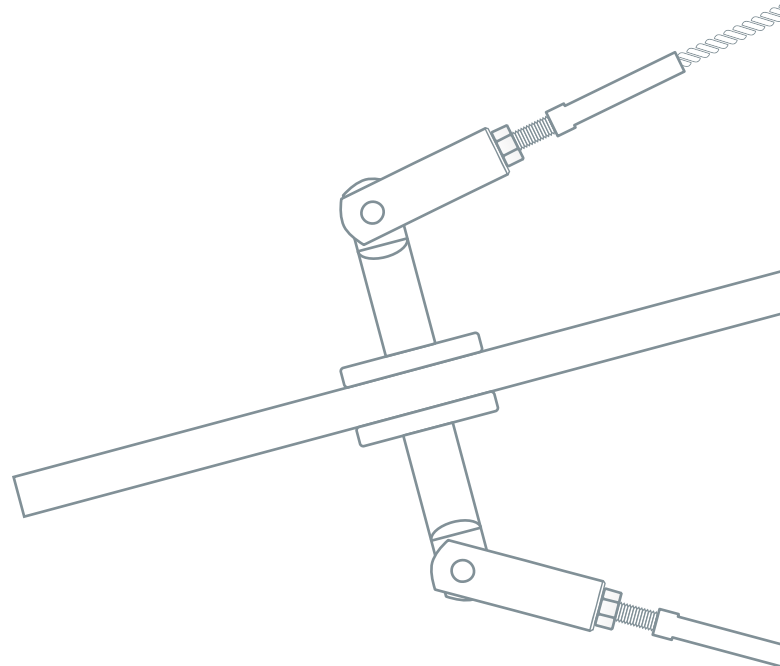

SICHERUNGEN_SAFETY

GELÄNDER_RAILINGS

SEIL-SYSTEME_CABLE SYSTEMS

BEGRÜNUNG_GREENERY

FASSADE_FACADE

GESTALTUNG_DESIGN

ZOO-ANLAGEN_ZOOLUTIONS

In diesen Referenz-Broschüren finden Sie I-SYS Anwendungen.

Discover more about I-SYS applications in our reference brochures.

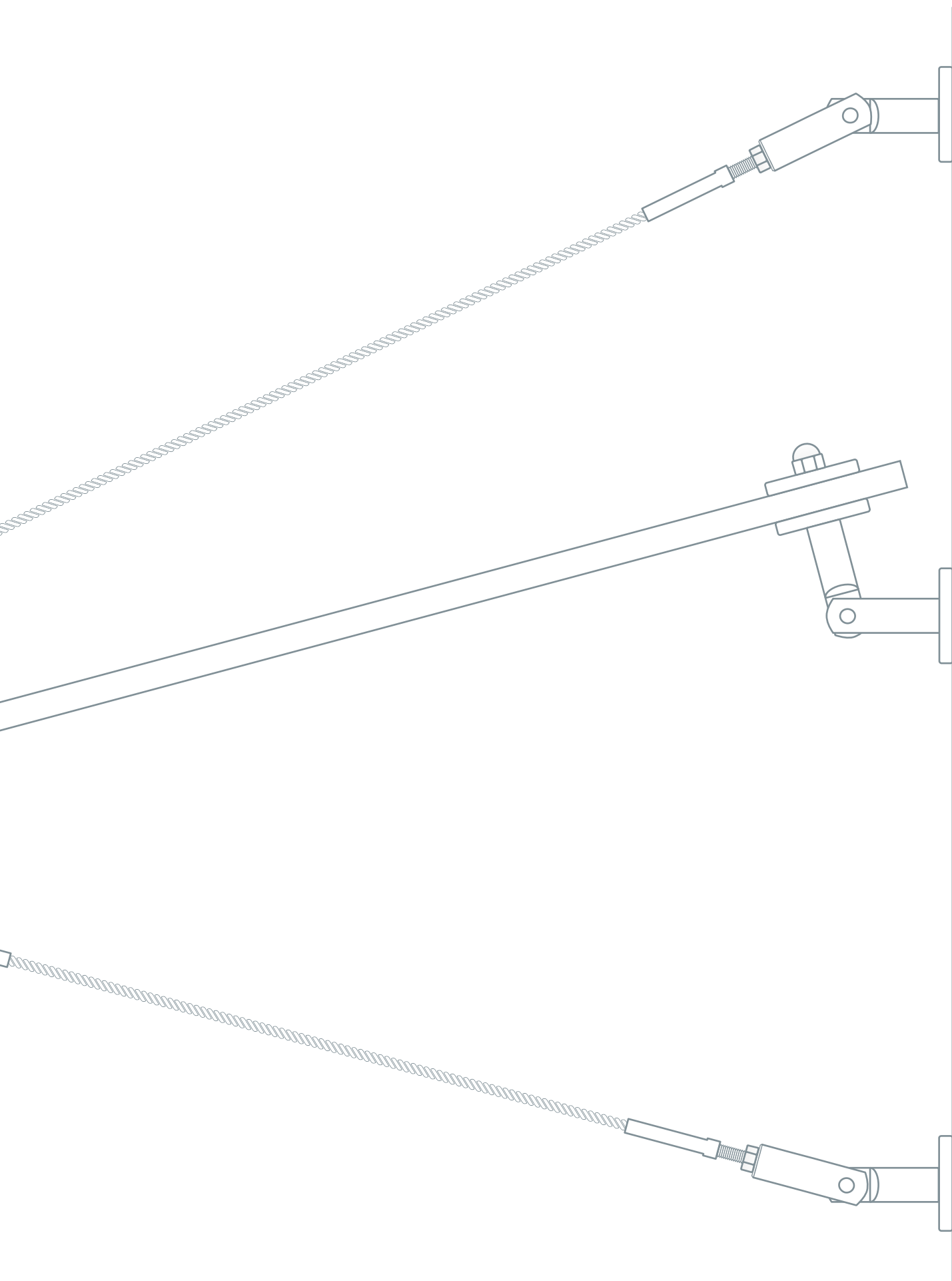

KRAFTVOLLE AUSSENWIRKUNG

STRONG AND HARMONIOUS LINKS

Aus Edelstahlseilen werden universelle Bauteile durch sinnvolle Anschlüsse, Verbindungen und Führungen. Sie müssen stark sein, um die wirkenden Kräfte aufzunehmen, und zugleich stimmig ins Bild der Architektur passen. Ein Spagat, den die Einzelteile von I-SYS meistern. Unter ihnen das filigrane F50, ein gehämmertes Außengewinde, das unterschiedliche Durchmesser von Edelstahlseil und Endverbindung formschlüssig harmonisiert.

Stainless steel cables are turned into universal elements by means of useful connectors, fittings and guides. They have to be strong in order to take up the forces which occur and at the same time they must harmonise with the architecture. A performance which the individual components of I-SYS negotiate with the greatest of ease. Including the jewel in the crown, the F50, a hammered external thread which brings together different diameters of stainless steel cable and final connectors in a perfect interference fit.





<p>Merkmale Attributes</p>	<ul style="list-style-type: none"> — Schlanker Schaftdurchmesser — Ermöglicht günstige Anschlusssteile — Ermöglicht kleinste Durchgangbohrungen — Minimale Reduzierung der Bruchlasten — Runde Optik, passend zum Seil — Slim shaft design — Optimal connection options — Very small through-holes — Only minimal reduction in breaking load — Round shape matches the cable
---------------------------------------	--

KOMPONENTEN

COMPONENTS

AUSSENGEWINDE, F50 GEHÄMMERT_EXTERNAL THREAD F50, HAMMERED

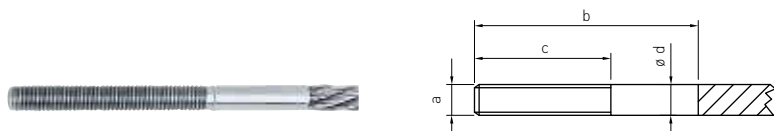

Artikelnummer Rechtsgewinde Part number RH thread	Artikelnummer Linksgewinde Part number LH thread	a	b	c	$\varnothing d^{+0,2}_0$	\varnothing Seil \varnothing rope	kN
950-0400-30	951-0400-30	M4	55	30	4,4	4	5,3
950-0400-60	951-0400-60	M4	85	60	4,4	4	5,3
950-0500-30	951-0500-30	M5	60	30	5,5	5	8,4
950-0500-60	951-0500-60	M5	90	60	5,5	5	8,4
950-0600-30	951-0600-30	M6	66	30	6,6	6	12,1
950-0600-60	951-0600-60	M6	96	60	6,6	6	12,1
950-0800-30	951-0800-30	M8	90	30	8,8	8	21,5
950-0800-60	951-0800-60	M8	120	60	8,8	8	21,5

Werkstoff 1.4404 | Nicht geeignet für Spiralseile 1x19 | kN = Bruchkraft_Material AISI 316L | Not suitable for strands 1x19| kN = breaking load

AUSSENGEWINDE, F30 GEHÄMMERT_EXTERNAL THREAD F30, HAMMERED



Artikelnummer Rechtsgewinde Part number RH thread	Artikelnummer Linksgewinde Part number LH thread	a	b	c	$\varnothing d^{+0,2}_0$	\varnothing Seil \varnothing rope	kN
948-0300-20	949-0300-20	M4	37	20	4	3	4
948-0300-40	949-0300-40	M4	57	40	4	3	4
948-0400-30	949-0400-30	M5	50	30	5	4	7,1
948-0400-50	949-0400-50	M5	70	50	5	4	7,1
948-0500-30	949-0500-30	M6	55	30	6	5	11,2
948-0500-50	949-0500-50	M6	75	50	6	5	11,2
948-0600-30	949-0600-30	M8	58	30	8	6	16
948-0600-60	949-0600-60	M8	88	60	8	6	16
948-0800-30	949-0800-30	M10	68	30	10	8	25
948-0800-60	949-0800-60	M10	98	60	10	8	25
948-1000-30	949-1000-30	M12	76	30	12	10	41,6
948-1000-60	949-1000-60	M12	106	60	12	10	41,6

Werkstoff 1.4404 | Nicht geeignet für Spiralseile 1x19 | kN = Bruchkraft_Material AISI 316L | Not suitable for strands 1x19| kN = breaking load

AUSSENGEWINDE, VERPRESST_EXTERNAL THREAD, SWAGED

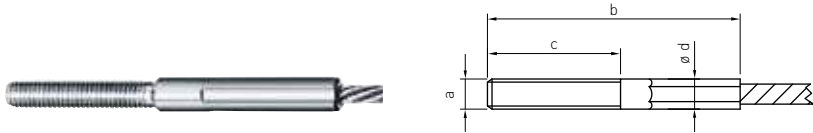

Artikelnummer Rechtsgewinde Part number RH thread	Artikelnummer Linksgewinde Part number LH thread	a	b	c	ø d	ø Seil ø rope	kN
850-0100-020	855-0100-020	M4	35	20	4	1	0,5
850-0200-030	855-0200-030	M5	55	30	5	2	2,8
850-0200-060	855-0200-060	M5	85	60	5	2	2,8
850-0300-030	855-0300-030	M6	70	30	6	3	6,3
850-0300-060	855-0300-060	M6	100	60	6	3	6,3
850-0400-030	855-0400-030	M6	75	30	7	4	11,2
850-0400-060	855-0400-060	M6	105	60	7	4	11,2
850-0400-061	855-0400-061	M8	105	60	8	4	11,2
850-0500-030	855-0500-030	M8	80	30	8	5	17,5
850-0500-060	855-0500-060	M8	110	60	8	5	17,5
850-0500-080	855-0500-080	M8	130	80	8	5	17,5
850-0600-030	855-0600-030	M10	90	30	10	6	25,2
850-0600-060	855-0600-060	M10	120	60	10	6	25,2
850-0600-080	855-0600-080	M10	140	80	10	6	25,2
850-0800-080	855-0800-080	M12	170	80	13	8	39,5
850-0800-120	855-0800-120	M12	210	120	13	8	39,5
850-1000-115	855-1000-115	M16	225	115	18	10	61,7
850-1200-130	855-1200-130	M20	245	130	20	12	83,2
850-1600-160	855-1600-160	M24	290	160	27	16	140

Werkstoff 1.4404 | kN = Bruchkraft_Material AISI 316L | kN = breaking load

GEWINDEFITTING, AUFGEROLLT_EXTERNAL THREAD, ROLL SWAGED



Artikelnummer Rechtsgewinde Part number RH thread	Artikelnummer Linksgewinde Part number LH thread	a	b	c	ø d	ø Seil ø rope
650-0600-045	655-0600-045	M10	117	45	12,5	6
650-0800-060	655-0800-060	M12	156	60	16,1	8
650-1000-076	655-1000-076	M14	193	76	17,8	10
650-1200-090	655-1200-090	M16	232	90	21,4	12
650-1400-110	655-1400-110	M20	259	110	24,9	14
650-1600-130	655-1600-130	M24	313	130	28	16
650-1800-140	655-1800-140	M27	357	140	34,5	18
650-2200-170	655-2200-170	M30	430	170	40,3	22
650-2600-170	655-2600-170	M36	475	170	45,9	26

Werkstoff 1.4404 | Europäische Technische Zulassung erteilt | Bruchkraft siehe Kapiteleinstieg "Zulassungen"

Material AISI 316L | European Technical Approval granted | for breaking load see introduction of the chapter "Approvals"

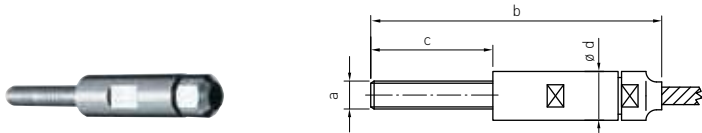
AUSSENGEWINDE, VERSCHRAUBT_EXTERNAL THREAD, SWAGELESS CONNECTION

Artikelnummer Rechtsgewinde Part number RH thread	Artikelnummer Linksgewinde Part number LH thread	a	b	c	ø d	ø Seil ø rope	kN
826-0200-030*	827-0200-030	M6	85	30	13	2	2
826-0200-060*	827-0200-060	M6	115	60	13	2	2
826-0300-030*	827-0300-030	M6	85	30	13	3	4,5
826-0300-060*	827-0300-060	M6	115	60	13	3	4,5
826-0400-030*	827-0400-030	M6	85	30	13	4	8
826-0400-060*	827-0400-060	M6	115	60	13	4	8
826-0500-030*	827-0500-030	M8	87	30	15	5	12,6
826-0500-060*	827-0500-060	M8	117	60	15	5	12,6
826-0600-030*	827-0600-030	M8	87	30	15	6	18,1
826-0600-060*	827-0600-060	M8	117	60	15	6	18,1
826-0800-080	827-0800-080	M10	190	100	22	8	32,2
826-1000-100	827-1000-100	M14	250	140	30	10	46,8
826-1200-120	827-1200-120	M16	265	140	32	12	67,6

Werkstoff 1.4404 | *Nicht geeignet für Spiralseil 1x19 | kN = Bruchkraft_Material AISI 316L | *Not suitable for strand 1x19 | kN = breaking load

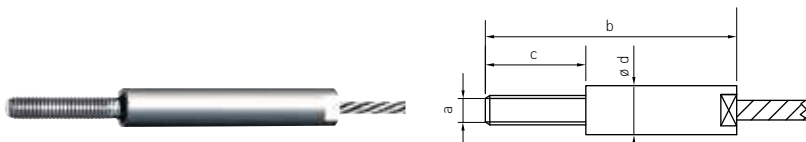
AUSSENGEWINDE DREHBAR, VERPRESST_EXTERNAL THREAD, SWIVEL SWAGED

Artikelnummer Part number	a	b	c	ø d	ø Seil ø rope	kN
856-0300-030	M6	88	30	10	3	4,5
856-0300-060	M6	118	60	10	3	4,5
856-0400-030	M6	88	30	10	4	8,1
856-0400-060	M6	118	60	10	4	8,1
856-0400-061	M8	118	60	10	4	8,1
856-0500-030	M8	108	30	13	5	12,6
856-0500-080	M8	158	80	13	5	12,6
856-0600-060	M10	138	60	13	6	14,5

Werkstoff 1.4404 | Nicht geeignet für Spiralseil 1 x 19 | kN = Bruchkraft_Material AISI 316L | Not suitable for strand 1 x 19 | kN = breaking load

SPANNSCHLOSS, VERPRESST_TURNBUCKLE THREADS, SWAGED

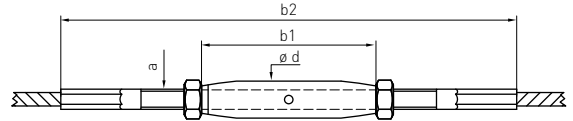

Artikelnummer Part number	a	b1	b2	ø d	ø Seil ø rope	Spannweg Adjustment	kN
829-0200-01	M5	80	166	8	2	+16 -26	2,8
829-0300-01	M6	92	207	10	3	+14 -26	6,3
829-0300-02	M6	92	250	10	3	+32 -44	6,3
829-0400-01	M6	92	217	10	4	+14 -26	11,2
829-0400-02	M6	92	260	10	4	+32 -44	11,2
829-0500-01	M8	112	248	13,5	5	+8 -24	17,5
829-0500-02	M8	112	280	13,5	5	+38 -54	17,5
829-0600-01	M10	120	314	17,2	6	+8 -50	25,5
829-0600-02	M10	120	340	17,2	6	+40 -60	25,5
829-0800-01	M12	150	425	21,3	8	+46 -70	39,5
829-1000-01	M16	190	560	26,9	10	+62 -94	61,7
829-1200-01	M20	220	646	33,7	12	+70 -110	83,2

Werkstoff 1.4404 | Außengewinde links/rechts, verpresst, sind je halb im Spannrohr eingeschraubt. Die minimale Einschraubtiefe beträgt 1,5 x Gewinde-ø (M8 = 12 mm) | kN = Bruchkraft

Material AISI 316L | Left/right swaged external threads are screwed half way into the turnbuckle. The minimum screw-in depth is 1.5 x thread ø (M8 = 12 mm) | kN = breaking load

SPANNSCHLOSS, F30 GEHÄMMERT_TURNBUCKLE THREADS, F30 HAMMERED

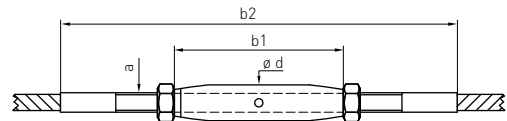

Artikelnummer Part number	a	b1	b2	ø d	ø Seil ø rope	Spannweg Adjustment	kN
828-0400-02	M5	80	160	8	4	+38 -42	7,1
828-0500-02	M6	92	178	10	5	+32 -40	11,2
828-0600-02	M8	112	214	13,5	6	+36 -47	16
828-0800-02	M10	120	236	17,2	8	+30 -44	25
828-1000-02	M12	150	280	21,3	10	+24 -40	41,6

Werkstoff 1.4404 | Außengewinde links/rechts, verpresst, sind je halb im Spannrohr eingeschraubt. Die minimale Einschraubtiefe beträgt 1,5 x Gewinde-ø (M8 = 12 mm) | Nicht geeignet für Spiralseile 1x19 | kN = Bruchkraft

Material AISI 316L | Left/right swaged external threads are screwed half way into the turnbuckle. The minimum screw-in depth is 1.5 x thread ø (M8 = 12 mm) | Not suitable for strand 1x19 | kN = breaking load

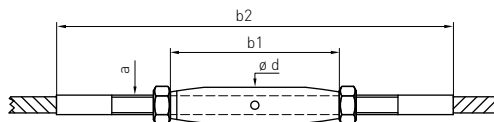
SPANNSCHLOSS, F50 GEHÄMMERT_TURNBUCKLE, F50 HAMMERED

Artikelnummer Part number	a	b1	b2	ø d	ø Seil ø rope	Spannweg Adjustment	kN
824-0500-02	M5	80	200	8	5	+30 -40	8,4
824-0600-02	M6	92	212	10	6	+34 -46	12,1
824-0800-02	M8	112	260	14	8	+50 -50	21,5

Werkstoff 1.4404 | Außengewinde links/rechts, verpresst, sind je halb im Spannröhre eingeschraubt. Die minimale Einschraubtiefe beträgt 1,5 x Gewinde-ø (M8 = 12 mm) | Nicht geeignet für Spiralseile 1x19 | kN = Bruchkraft

Material AISI 316L | Left/right swaged external threads are screwed half way into the turnbuckle. The minimum screw-in depth is 1.5 x thread ø (M8 = 12 mm) | Not suitable for strand 1x19 | kN = breaking load

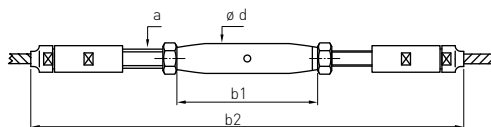
SPANNSCHLOSS, VERSCHRAUBT_TURNBUCKLE, SWAGLESS

Artikelnummer Part number	a	b1	b2	ø d	ø Seil ø rope	Spannweg Adjustment	kN
825-0600-02*	M8	112	286	14	6	+45 -45	18
825-0800-02	M10	120	374	18	8	+60 -60	32
825-1000-02	M14	150	496	21	10	+70 -70	46
825-1200-02	M16	190	584	27	12	+80 -80	67

Werkstoff 1.4404 | *Nicht geeignet für Spiralseile 1x19 | Außengewinde links/rechts, verschraubt, sind je halb im Spannröhre eingeschraubt. Die minimale Einschraubtiefe beträgt 1,5 x Gewinde-ø (M8 = 12 mm) | kN = Bruchkraft

Material AISI 316L | *Not suitable for strand 1 x 19 | Left/right swaged external threads are screwed half way into the turnbuckle. The minimum screw-in depth is 1.5 x thread ø (M8 = 12 mm) | kN = breaking load

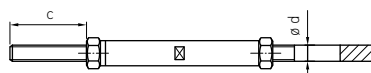
**SPANNSCHLOSS ZYLINDRISCH MIT GEWINDE, F30 GEHÄMMERT
TURNBUCKLE CYLINDRICAL WITH THREAD, F30 HAMMERED**

Artikelnummer Part number	ø Seil ø rope	Gewinde rechtsgängig Größe x Länge c Thread right hand size x length	ø d ^{+0,2} ₀	kN
130-0400	4	M5 x 60	5	7,1
130-0500	5	M6 x 60	6	11
130-0600	6	M8 x 60	8	16

Nicht geeignet für Spiralseile 1x19 | kN = Bruchkraft | Not suitable for strand 1x19 | kN = breaking load

SPANNSCHLOSS MIT GEWINDE, GEHÄMMERT_TURNBUCKLE WITH THREAD HAMMERED



Artikelnummer Part number	a	b	c	$\varnothing d \begin{smallmatrix} +0,2 \\ 0 \end{smallmatrix}$	\varnothing Seil \varnothing rope	Spannweg Adjustment	kN
110-0400-F30	M5	190	60	5	4	+25 -35	7
110-0500-F30	M6	201	57	6	5	+30 -40	11,2
110-0600-F30	M8	240	65	8	6	+30 -50	16
110-0800-F30	M10	258	70	10	8	+35 -55	25
110-1000-F30	M12	286	70	12	10	+35 -60	41,6

Werkstoff 1.4401 | Nicht geeignet für Spiralseile 1x19 | kN = Bruchkraft_Material AISI 316 | Not suitable for strand 1x19 | kN = breaking load

SPANNSCHLOSS MIT GEWINDE, VERPRESST_TURNBUCKLE, WITH THREAD SWAGED



Artikelnummer Part number	a	b	c	$\varnothing d$	\varnothing Seil \varnothing rope	Spannweg Adjustment	kN
110-0200	M5	205	60	5	2	+30 -40	2,8
110-0300	M6	205	60	6	3	+30 -40	6,3
110-0400	M6	231	60	7	4	+30 -40	11,2
110-0401	M8	247	60	8	4	+40 -50	11,2
110-0500	M8	273	60	8	5	+40 -50	17,5
110-0600	M10	300	70	10	6	+40 -60	25,2
110-0800	M12	360	70	13	8	+40 -90	25,2
110-1000	M16	435	70	18	10	+60 -90	39,5
110-1200	M20	495	70	20	12	+60 -120	83,2
110-1600	M24	658	70	27	16	+70 -208	140

Werkstoff 1.4401 | kN = Bruchkraft_Material AISI 316 | kN = breaking load

KONFEKTIONEN: AUSSENGEWINDE

ASSEMBLY DRAWINGS: EXTERNAL SCREW THREAD

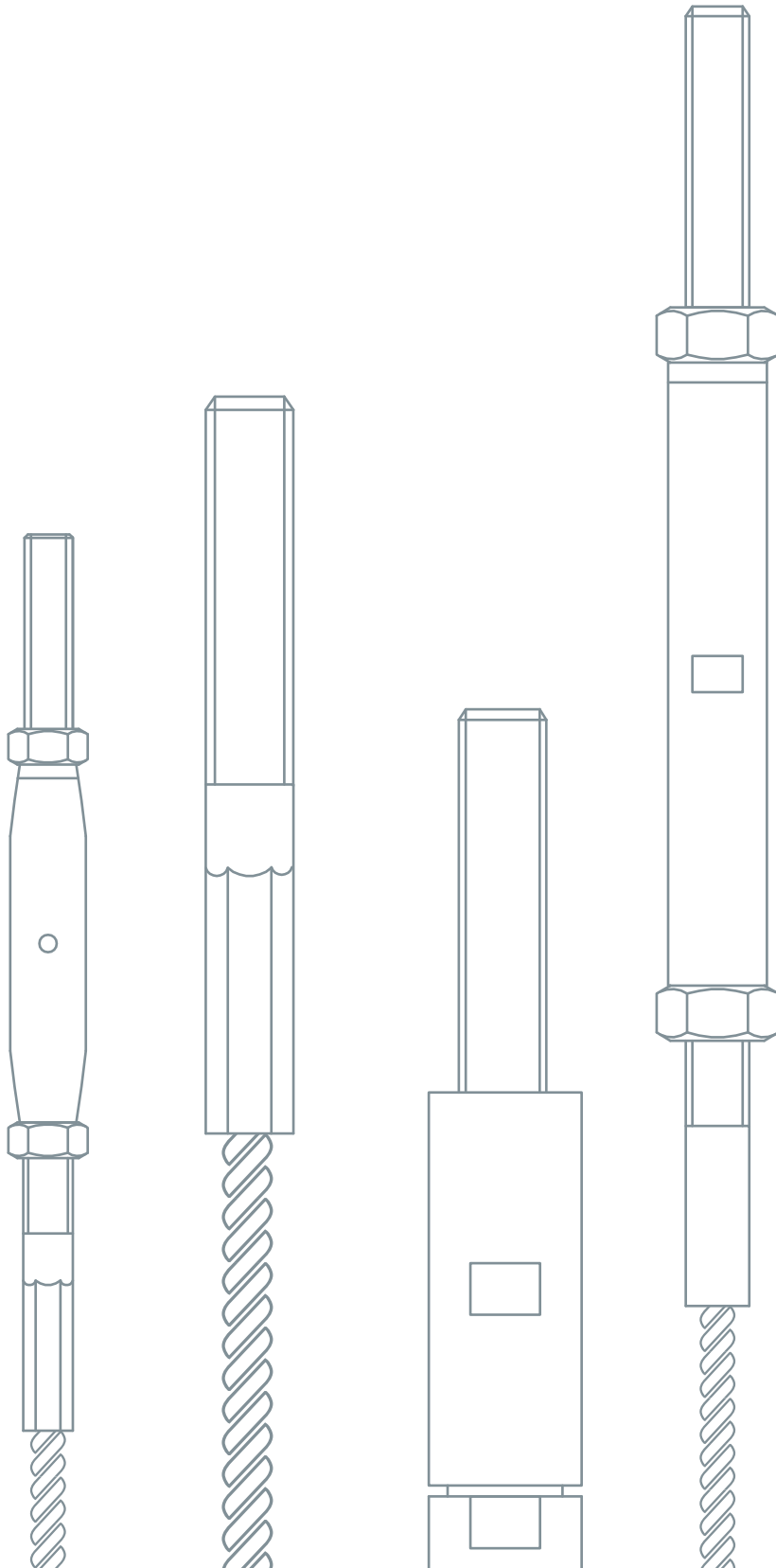

BEIDE SEITEN AUSSENGEWINDE, VERPRESST_BOTH SIDES EXTERNAL THREAD, SWAGED

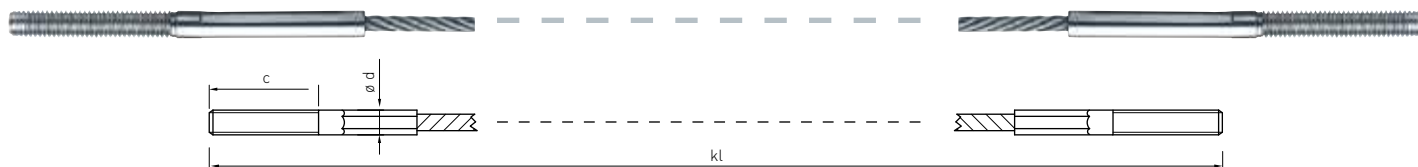

Artikelnummer Beide Seiten Rechtsgewinde Part number both sides RH thread	Artikelnummer Eine Seite Rechts-, andere Linksgew. Part number one LH thread one RH thread	ø Seil ø rope	Sk	Gewinde Größe x Länge c Thread size x length	ø d	kl min	kN
IK 100-0200	IK 101-0200	2	7 x 7	M5 x 30	5	150	2,2
IK 100-0201	IK 101-0201	2	7 x 7	M5 x 60	5	200	2,2
IK 100-0300	IK 101-0300	3	7 x 7	M6 x 30	6	180	5
IK 100-0301	IK 101-0301	3	7 x 7	M6 x 60	6	235	5
IK 100-0400	IK 101-0400	4	7 x 7	M6 x 30	7	180	8,9
IK 100-0401	IK 101-0401	4	7 x 7	M6 x 60	7	250	8,9
IK 100-0500	IK 101-0500	5	7 x 7	M8 x 30	8	210	14
IK 100-0501	IK 101-0501	5	7 x 7	M8 x 60	8	270	14
IK 100-0600	IK 101-0600	6	7 x 7	M10 x 30	10	230	20
IK 100-0601	IK 101-0601	6	7 x 7	M10 x 60	10	290	20
IK 100-0800	IK 101-0800	8	7 x 7	M12 x 80	13	410	35
IK 100-1000	IK 101-1000	10	7 x 19	M16 x 115	18	530	52
IK 100-1200	IK 101-1200	12	7 x 19	M20 x 130	20	590	75
IK 100-1600	IK 101-1600	16	7 x 19	M24 x 160	27	730	133

kN = Bruchkraft_kN = breaking load

**BEIDE SEITEN SPANNSCHLOSS MIT AUSSENGEWINDE, VERPRESST
BOTH SIDES TURNBUCKLE WITH EXTERNAL THREAD, SWAGED**

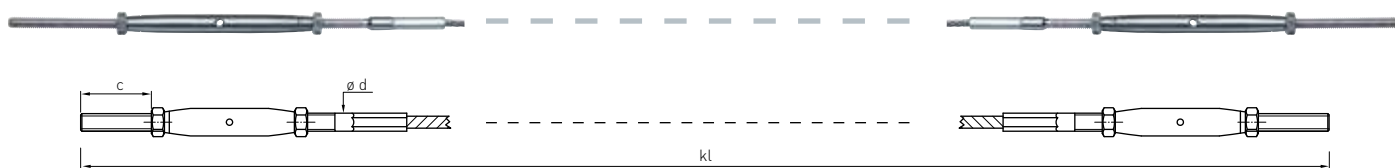

Artikelnummer Beide Seiten Rechtsgewinde Part number both sides RH thread	ø Seil ø rope	Sk	Gewinde Größe x Länge c Thread size x length	Spannweg Adjustment	ø d	kl min	kN
IK 110-0200	2	7 x 7	M5 x 60	+52 -86	5	440	2,2
IK 110-0300	3	7 x 7	M6 x 60	+56 -100	6	480	5
IK 110-0400	4	7 x 7	M6 x 60	+56 -100	7	500	8,9
IK 110-0500	5	7 x 7	M8 x 60	+68 -100	8	590	14
IK 110-0600	6	7 x 7	M10 x 60	+60 -100	10	650	20
IK 110-0800	8	7 x 7	M12 x 60	+92 -140	13	790	35
IK 110-1000	10	7 x 19	M16 x 60	+96 -180	18	950	52
IK 110-1200	12	7 x 19	M20 x 60	+120 -210	20	1100	75
IK 110-1600	16	7 x 19	M24 x 60	+180 -240	27	1500	133

kN = Bruchkraft_kN = breaking load

BEIDE SEITEN AUSSENGEWINDE, F30 GEHÄMMERT_BOTH SIDES EXTERNAL THREAD, F30 HAMMERED

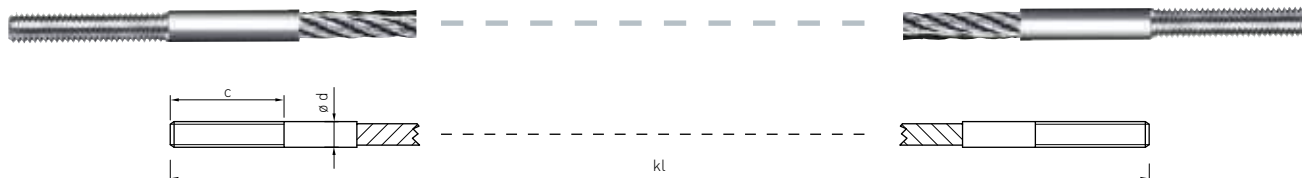

Artikelnummer Beide Seiten Rechtsgewinde Part number both sides RH thread	Artikelnummer Eine Seite Rechts-, andere Linksgew. Part number one LH thread one RH thread	ø Seil ø rope	Sk	Gewinde Größe x Länge c Thread size x length	ø d ^{+0,2} ₀	kl min	kN
IK 120-0300	IK 121-0300	3	7 x 7	M4 x 20	4	170	4,0
IK 120-0301	IK 121-0301	3	7 x 7	M4 x 40	4	200	4,0
IK 120-0400	IK 121-0400	4	7 x 7	M5 x 30	5	220	7,1
IK 120-0401	IK 121-0401	4	7 x 7	M5 x 50	5	240	7,1
IK 120-0500	IK 121-0500	5	7 x 7	M6 x 30	6	220	11
IK 120-0501	IK 121-0501	5	7 x 7	M6 x 50	6	240	11
IK 120-0600	IK 121-0600	6	7 x 7	M8 x 30	8	230	16
IK 120-0601	IK 121-0601	6	7 x 7	M8 x 60	8	270	16
IK 120-0800	IK 121-0800	8	7 x 7	M10 x 30	10	240	25
IK 120-0801	IK 121-0801	8	7 x 7	M10 x 60	10	280	25
IK 120-1000	IK 121-1000	10	7 x 19	M12 x 30	12	250	41
IK 120-1001	IK 121-1001	10	7 x 19	M12 x 60	12	310	41

kN = Bruchkraft_kN = breaking load

BEIDE SEITEN AUSSENGEWINDE, F50 GEHÄMMERT_BOTH SIDES EXTERNAL THREAD, F50 HAMMERED

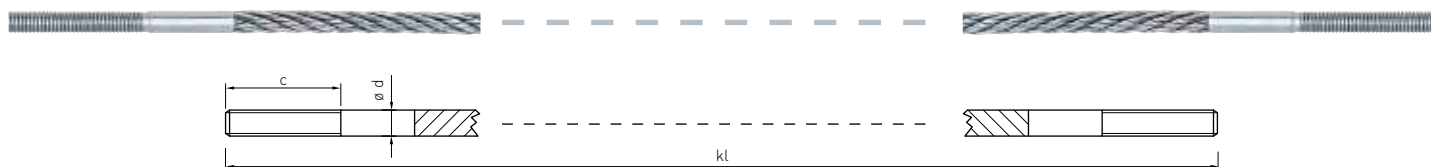

Artikelnummer Beide Seiten Rechtsgewinde Part number both sides RH thread	Artikelnummer Eine Seite Rechts-, andere Linksgew. Part number one LH thread one RH thread	ø Seil ø rope	Sk	Gewinde Größe x Länge c Thread size x length	ø d ^{+0,2} ₀	kl min	kN
IK 125-0400	IK 126-0400	4	7 x 7	M4 x 30	4,4	210	5,3
IK 125-0401	IK 126-0401	4	7 x 7	M4 x 60	4,4	280	5,3
IK 125-0500	IK 126-0500	5	7 x 7	M5 x 30	5,5	220	8,4
IK 125-0501	IK 126-0501	5	7 x 7	M5 x 60	5,5	280	8,4
IK 125-0600	IK 126-0600	6	7 x 7	M6 x 30	6,6	230	12
IK 125-0601	IK 126-0601	6	7 x 7	M6 x 60	6,6	290	12
IK 125-0800	IK 126-0800	8	7 x 7	M8 x 30	8,8	280	21
IK 125-0801	IK 126-0801	8	7 x 7	M8 x 60	8,8	340	21

kN = Bruchkraft_kN = breaking load

BEIDE SEITEN SPANNSCHLOSS MIT AUSSENGEWINDE, F30 GEHÄMMERT
 BOTH SIDES TURNBUCKLE WITH EXTERNAL THREAD, F30 HAMMERED

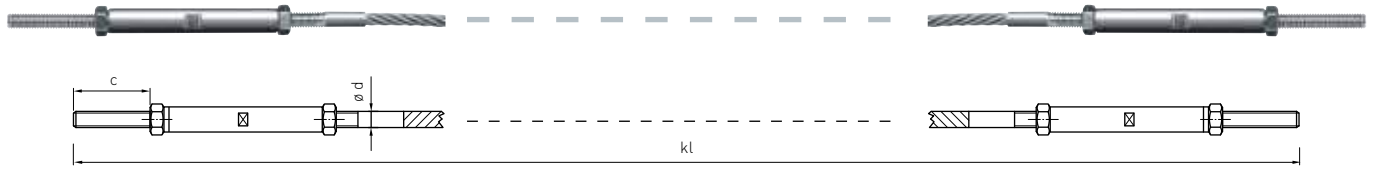

Artikelnummer Beide Seiten Rechtsgewinde Part number both sides RH thread	ø Seil ø rope	Sk	Gewinde Größe x Länge c Thread size x length	Spannweg Adjustment	ø d ^{+0,2} ₀	kl min	kN
IK 130-0400	4	7 x 7	M5 x 60	+60 -90	5	450	7,1
IK 130-0500	5	7 x 7	M6 x 60	+74 -110	6	500	11
IK 130-0600	6	7 x 7	M8 x 60	+74 -110	8	530	16

kN = Bruchkraft_kN = breaking load

MONTAGEBEISPIELE

INSTALLATION EXAMPLES

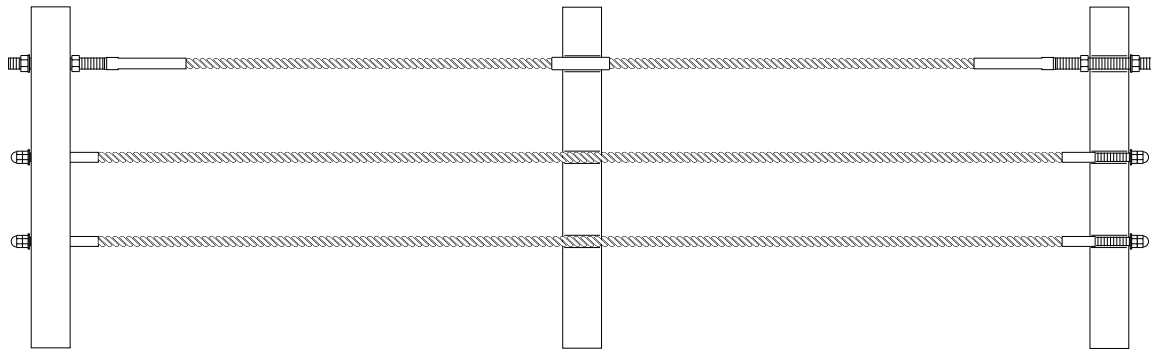

Beispiel 1_Example 1

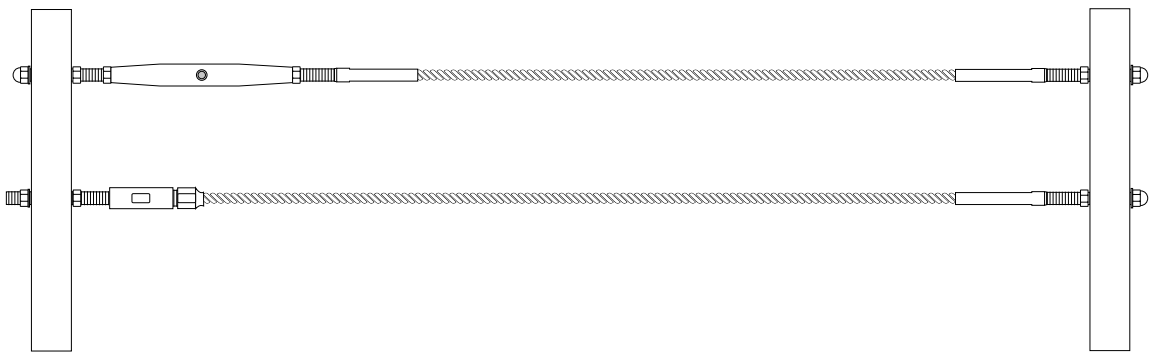

Beispiel 2_Example 2

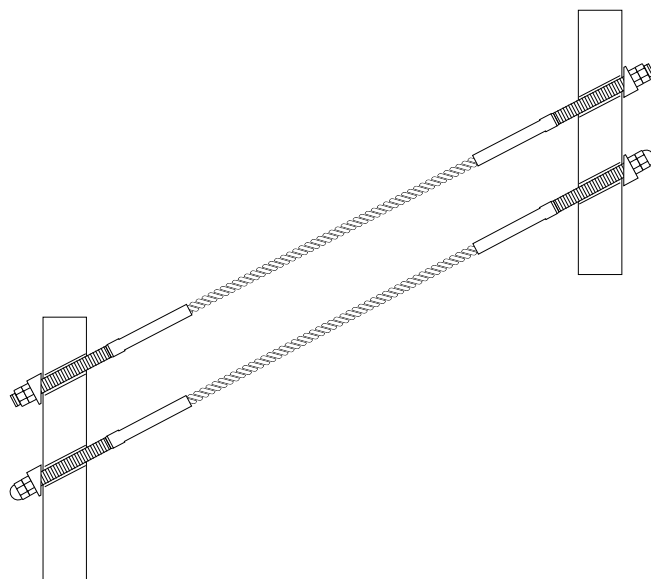

Beispiel 3_Example 3

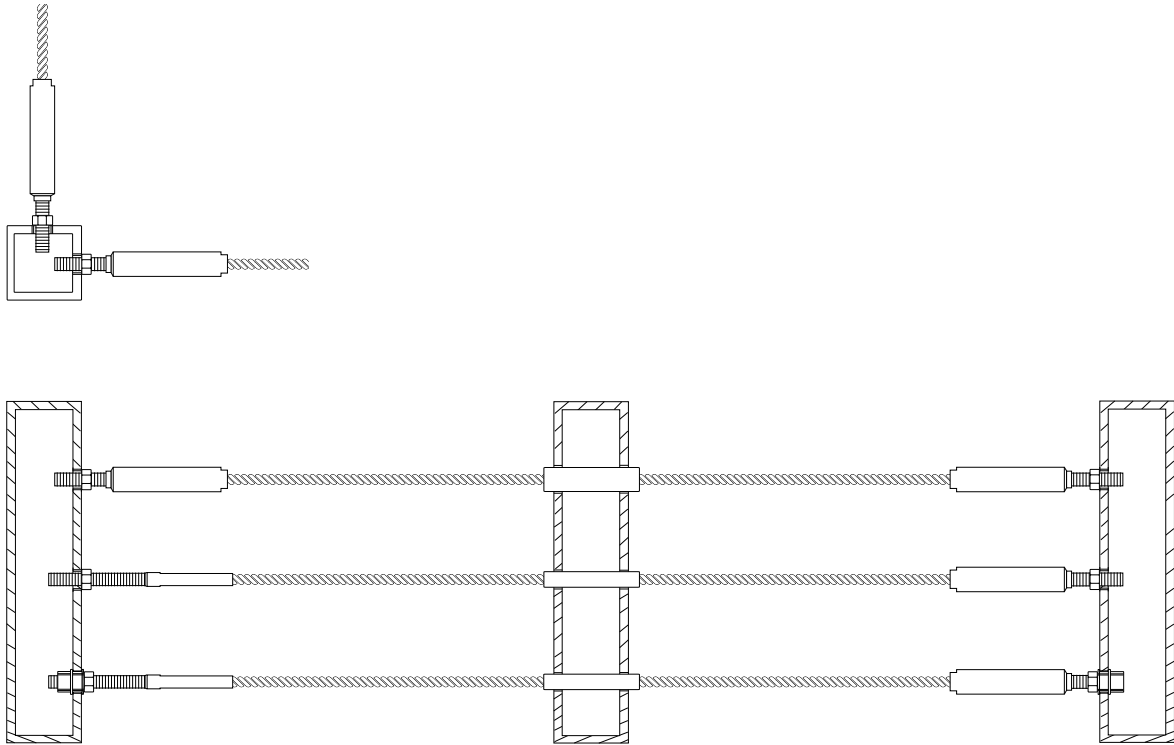

Beispiel 4_Example 4

<p>Beispiel 1 Example 1</p>	<p>Spannung im Seil entsteht durch Anziehen der Muttern. Seilhülsen dienen dem Schutz von Seilen und beschichteten Pfostenprofilen gegen Abrieb.</p> <p>Tension is created within the cable by tightening the nuts. Loose sleeves serve to protect the cables and coated post profiles against abrasion.</p>
<p>Beispiel 2 Example 2</p>	<p>Den Ausgleich großer Toleranzen erlauben Konfektionen mit Spannschlössern und Endverbindungen zur Selbstmontage.</p> <p>Turnbuckles and self assembled end connections allow to compensate large tolerances.</p>
<p>Beispiel 3 Example 3</p>	<p>Den Steigungswinkel von schrägen Seilführungen gleichen Formanschlüsse an den Pfosten aus.</p> <p>Preformed connections at the posts compensate for angle changes of cables.</p>
<p>Beispiel 4 Example 4</p>	<p>Sollen die Pfosten nicht durchdrungen werden, kann in die Wandung ein Innengewinde geschnitten oder eine Einnietmutter gesetzt werden.</p> <p>If the posts are not to be penetrated, an internal thread can be cut in the wall or a riveted nut can be used.</p>

INNERER HALT INNER STABILITY

Lange Strecken aus edlen Seilen zieren Brücken, Plätze und Geländer. Sie dienen der Sicherheit, grenzen Nutzungen voneinander ab oder markieren Strukturen im öffentlichen Raum. Für die richtige Spannung sorgen Pfosten mit Seilstößen in einem angemessenen Rhythmus. Innengewinde leisten dafür beste Dienste. Auf ein formales Minimum reduziert halten sich so die Seile auf Maß und parallel zueinander.

Long lengths of splendid cable can be seen in bridges and on stairways. They provide safety, divide different areas of use from one another or mark structures in public spaces. Generous forms require the cables to be strung in the right rhythm. Internal threads do sterling service here. Reduced to a minimum as regards form, they secure the cable fixing, maintain cables at the right lengths and keep them parallel to one another.



**Merkmale**
Attributes

- Vielfältige Anschlussmöglichkeiten
- Optimal abgestimmte Schaftdurchmesser
- Kostengünstige Seilstöße bei langen Distanzen
- Wide range of possible connections
- Optimally coordinated shaft diameters
- Economical cable stops for long distances

KOMPONENTEN

COMPONENTS

INNENGEWINDE, VERPRESST_INTERNAL THREAD, SWAGED



Artikelnummer Rechtsgewinde Part number RH thread	Artikelnummer Linksgewinde Part number LH thread	a	b	c	$\varnothing d$	\varnothing Seil \varnothing rope	kN
860-0200-015	861-0200-015	M4	45	15	6	2	2,9
860-0300-020	861-0300-015	M5	60	20	7	3	6,7
860-0400-020	861-0400-020	M6	65	20	8	4	11,8
860-0400-035	861-0400-035	M6	90	35	8	4	11,8
860-0500-020	861-0500-020	M6	70	20	8	5	12
860-0500-035	861-0500-035	M6	100	35	8	5	12
860-0600-025	861-0600-025	M8	90	25	10	6	16,5
860-0600-050	861-0600-050	M8	120	50	10	6	16,5
860-0800-060	861-0800-060	M10	180	60	13	8	26
860-1000-080	861-1000-080	M12	170	80	18	10	69,5
860-1000-081	861-1000-081	M14	185	80	20	10	69,5
860-1200-100	861-1200-100	M16	210	100	24	12	93,6
860-1600-120	861-1600-120	M20	250	120	30	16	133

Werkstoff 1.4404 | kN = Bruchkraft_Material AISI 316L | kN = breaking load

INNENGEWINDE DREHBAR, VERPRESST_INTERNAL THREAD SWIVEL, SWAGED



Artikelnummer Part number	a	b	c	$\varnothing d1$	$\varnothing d2$	\varnothing Seil \varnothing rope	kN
857-0300-020	M5	91	20	10	8	3	4,6
857-0300-035	M5	113	35	10	8	3	4,6
857-0400-020	M6	91	20	10	8	4	8,1
857-0400-035	M6	113	35	10	8	4	8,1
857-0500-020	M6	111	20	13	10	5	12
857-0500-035	M6	133	35	13	10	5	12
857-0600-025	M8	116	25	13	10	6	12,5
857-0600-050	M8	148	50	13	10	6	12,5

Werkstoff 1.4404 | Nicht geeignet für Spiralseil 1 x 19 | kN = Bruchkraft_Material AISI 316L | Not suitable for strand 1 x 19 | kN = breaking load

INNENGEWINDE, VERSCHRAUBT_INTERNAL THREAD, SWAGELESS CONNECTION

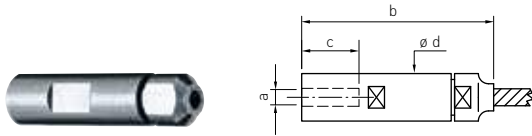

Artikelnummer Rechtsgewinde Part number RH thread	Artikelnummer Linksgewinde Part number LH thread	a	b	c	ø d	ø Seil ø rope	kN
831-0200*	832-0200	M6	55	18	13	2	2
831-0300*	832-0300	M6	55	18	13	3	4,5
831-0400*	832-0400	M6	55	18	13	4	8
831-0500*	832-0500	M8	57	20	15	5	12,6
831-0600*	832-0600	M8	57	20	15	6	18,1
831-0800	832-0800	M10	90	40	22	8	32,2
831-1000	832-1000	M14	110	40	30	10	46,8
831-1200	832-1200	M16	125	40	32	12	67,6

Werkstoff 1.4404 | *Nicht geeignet für Spiralseil 1x19 | kN = Bruchkraft_Material AISI 316L | *Not suitable for strand 1x19 | kN = breaking load

MONTAGEPRINZIP

INSTRUCTION



KONFEKTIONEN: INNENGEWINDE

ASSEMBLY DRAWINGS: INTERNAL SCREW THREAD

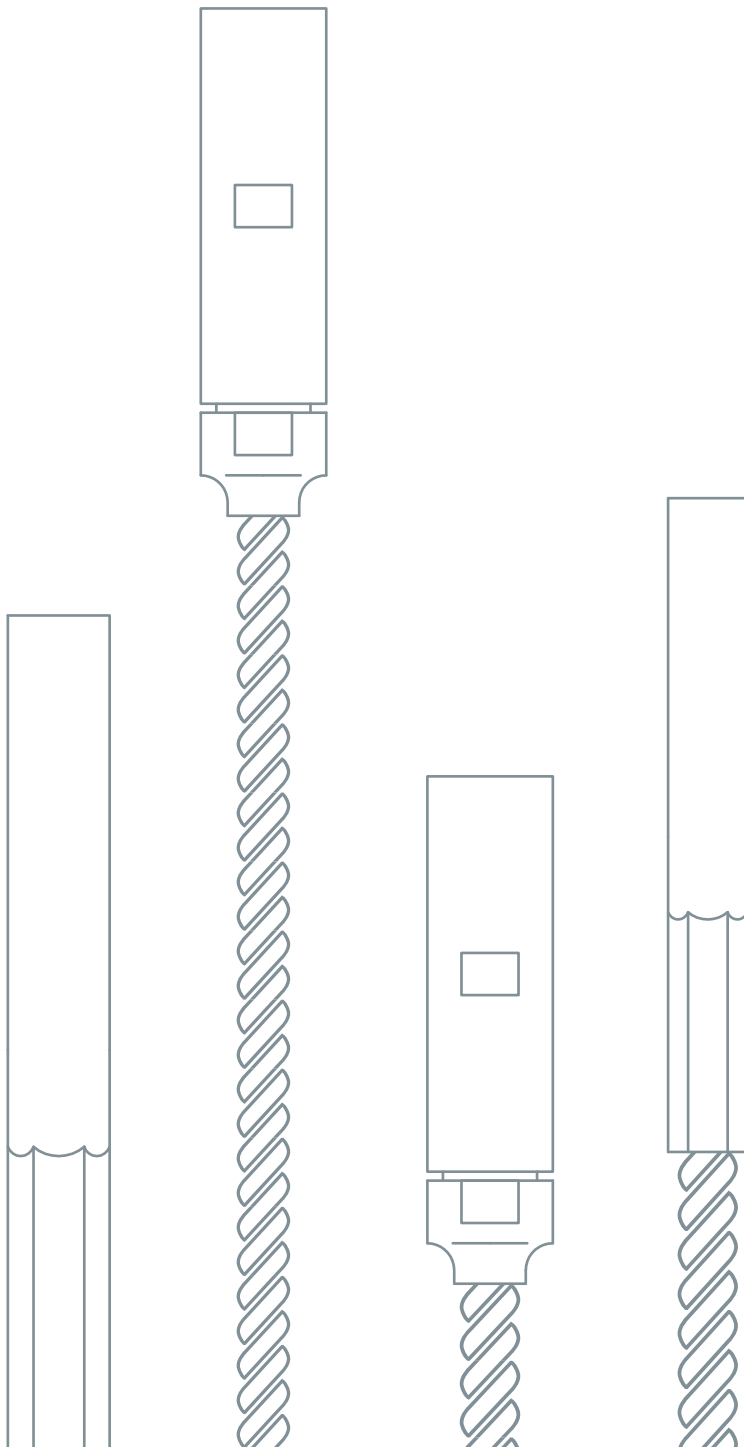

BEIDE SEITEN INNENGEWINDE, VERPRESST_BOTH SIDES INTERNAL, THREAD SWAGED

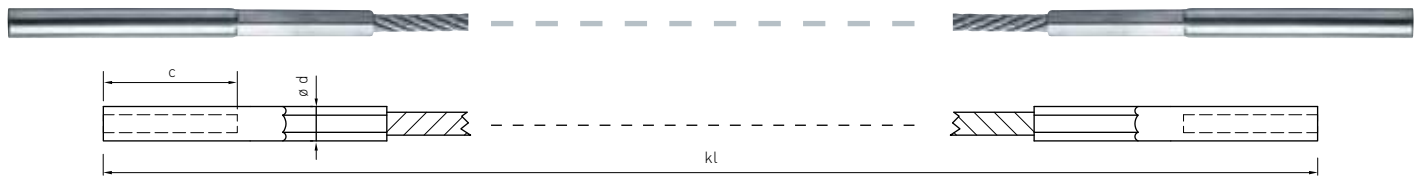

Artikelnummer Beide Seiten Rechtsgewinde Part number both sides RH thread	Artikelnummer Eine Seite Rechts-, andere Linksgew. Part number one LH thread one RH thread	ø Seil ø rope	Sk	Gewinde Größe x Länge c Thread size x length c	ø d	kl min	kN
IK 200-0200	IK 201-0200	2	7 x 7	M4 x 15	6	130	2,2
IK 200-0300	IK 201-0300	3	7 x 7	M5 x 20	7	160	5
IK 200-0301	IK 201-0301	3	7 x 7	M5 x 35	7	220	5
IK 200-0400	IK 201-0400	4	7 x 7	M6 x 20	8	180	8,9
IK 200-0401	IK 201-0401	4	7 x 7	M6 x 35	8	230	8,9
IK 200-0500	IK 201-0500	5	7 x 7	M6 x 20	8	190	12
IK 200-0501	IK 201-0501	5	7 x 7	M6 x 35	8	250	12
IK 200-0600	IK 201-0600	6	7 x 7	M8 x 25	10	240	16
IK 200-0601	IK 201-0601	6	7 x 7	M8 x 50	10	300	16
IK 200-0800	IK 201-0800	8	7 x 7	M10 x 60	13	440	26
IK 200-1000	IK 201-1000	10	7 x 19	M12 x 80	18	440	69
IK 200-1200	IK 201-1200	12	7 x 19	M16 x 100	24	540	75
IK 200-1600	IK 201-1600	16	7 x 19	M20 x 120	30	660	133

kN = Bruchkraft_kN = breaking load

MONTAGEBEISPIELE

INSTALLATION EXAMPLES

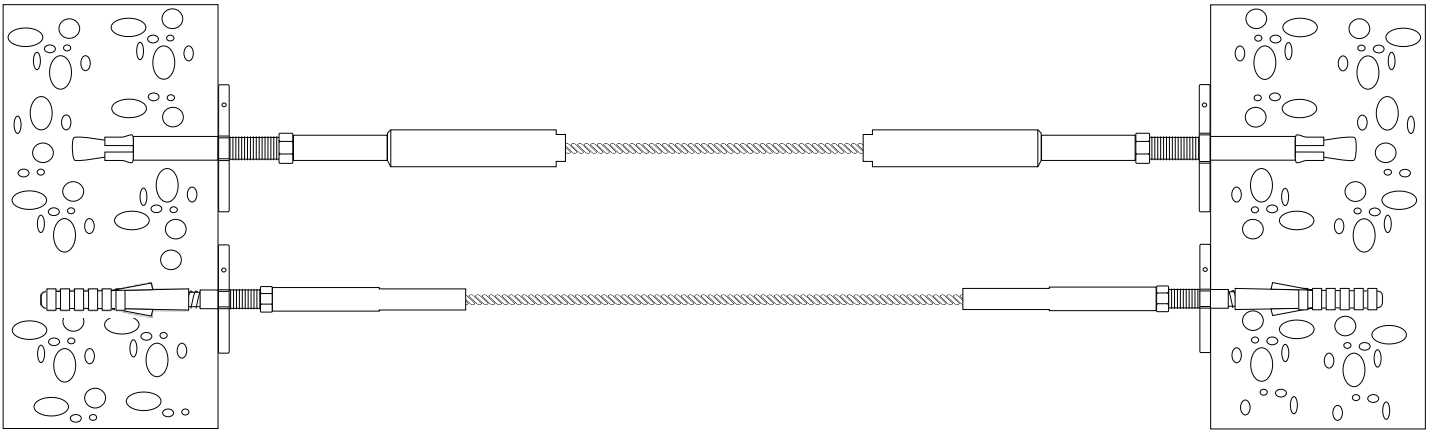

Beispiel 1_Example 1

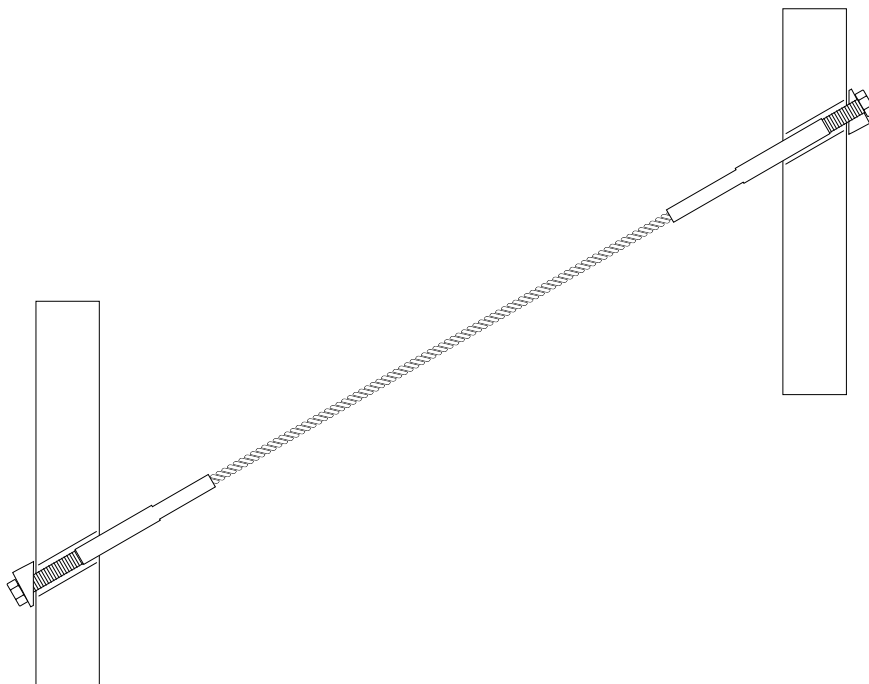

Beispiel 2_Example 2

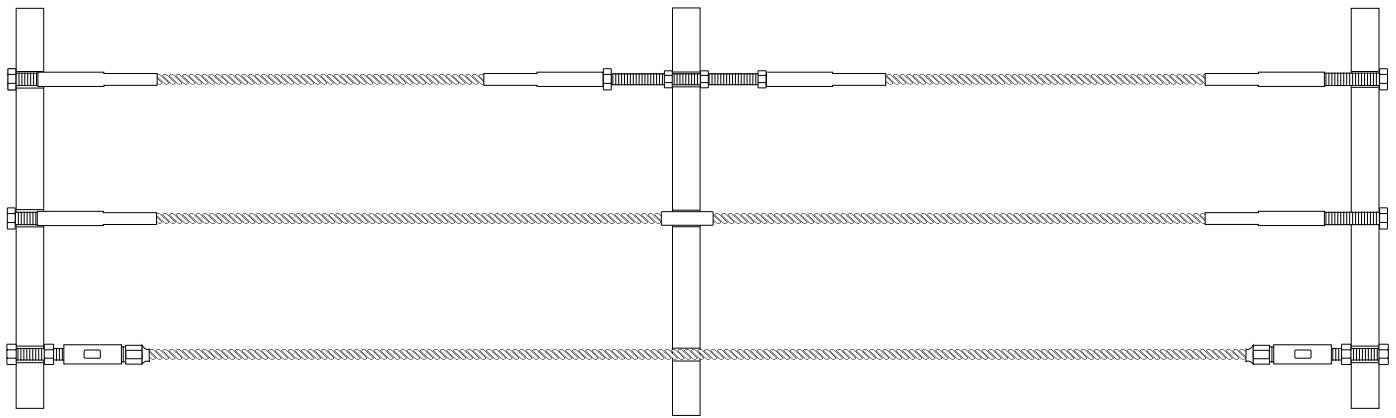

Beispiel 3_Example 3

<p>Beispiel 1 Example 1</p>	<p>Für die Befestigung der Konfektionen mit Innengewinde auf den verschiedenen Untergründen steht passendes I-SYS Zubehör zur Wahl.</p> <p>I-SYS accessories are available for fixing cable assemblies with internal thread to the different bases.</p>
<p>Beispiel 2 Example 2</p>	<p>Den Steigungswinkel von schrägen Seilführungen gleichen Formanschlüsse an den Pfosten aus. Gewindesicherung verwenden.</p> <p>Preformed connections at the posts compensate for the angle changes. Use thread lock fluid.</p>
<p>Beispiel 3 Example 3</p>	<p>Ein Seilstoß mit Innengewinde am Pfosten sorgt für die Spannung der Seile auf bis zu 10 Meter Einzellänge (oben). Seilhülsen schützen Seile und Beschichtungen am Pfosten (mittig). Für kurze Strecken reichen Verspannungen an den Endpfosten (unten). Gewindesicherung verwenden.</p> <p>A cable stop with internal thread at the post fixes the cable up to 10 metres each in length (top). Loose sleeves protect the cable and finish of the post (centre). Tensioning at the end posts is sufficient for short lengths (below). Use thread lock fluid.</p>

SCHÖNHEIT, DIE VERBINDET

ATTRACTIVE CONNECTIONS

Schlank und zart, dennoch stark belastbar und langlebig soll sie sein: Die Verbindung von Seil und Bau verlangt intelligentes Design. Das I-SYS Programm besticht hier mit einer einmaligen Ästhetik. Technisch ausgefeilte Edelstahlverarbeitung in Verbindung mit organischer Formensprache zieren die CS-Gabeln und CS-Ösen. Die international besetzte Jury der führenden Architekturzeitschrift AIT zeichnete die Innovation des I-SYS Programms mit einer Auszeichnung und würdigte damit die neue Eleganz der industriellen Elemente.

Slim and elegant, but strong and long lived: these are the requirements placed on connections between cable and building. Intelligent design is absolutely essential. The I-SYS range impresses with its unique aesthetic qualities. Refined technical processing of the stainless steel in conjunction with organic forms are typical of CS-Forks and CS-Eyes. The international jury of the leading architectural journal AIT awarded the range the highly-regarded „Innovation Prize for Architecture and Construction“, recognising the new elegance of these industrial elements.





Merkmale
Attributes

- **Vielfältige Lösungsmöglichkeiten**
- **Designorientierte Lösungen**
- **Aufeinander abgestimmte Anschlusselemente**
- Wide range of possible solutions
- Design-oriented
- Optimally coordinated connection elements

KOMPONENTEN

COMPONENTS

GABEL MIT AUSSENGEWINDE_FORK WITH EXTERNAL THREAD

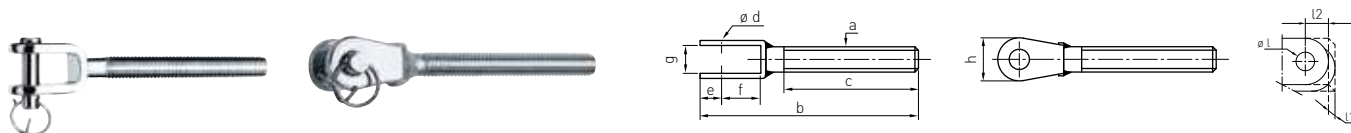

Artikelnummer Rechtsgewinde Part number RH thread	Artikelnummer Linksgewinde Part number LH thread	a	b	c	e	f	g	h	ø d	l1	l2	ø l
871-0500-01	872-0500-01	M5	55	30	6	12	7,5	12,5	5	6	10	5,5
871-0500	872-0500	M5	66	41	6	12	7,5	12,5	5	6	10	5,5
871-0600-01	872-0600-01	M6	56	30	6	12	7,5	12,5	5	6	10	5,5
871-0600	872-0600	M6	73	47	6	12	7,5	12,5	5	6	10	5,5
871-0800-01	872-0800-01	M8	64	35	7	13	10	14,5	6	8	10	6,5
871-0800	872-0800	M8	86	57	7	13	10	14,5	6	8	10	6,5
871-1000	872-1000	M10	99	63	9	15	11	18	8	9	12	8,5
871-1200	872-1200	M12	133	80	14	25	14	26	12	13	20	12,5
871-1400	872-1400	M14	143	90	14	25	14	26	12	13	20	12,5
871-1600	872-1600	M16	167	100	18	31	22	34	14	20	23	14,5
871-2000	872-2000	M20	214	119	22	42	24	42	19	22	32	19,5
871-2400	872-2400	M24	286	170	28	50	30	50	25	28	46	25,5

Werkstoff 1.4401_Material AISI 316

SPANNSCHLOSS MIT ZWEI GABELN_TURNBUCKLE WITH TWO FORKS



Artikelnummer Part number	a	b	f	g	ø d	Spannweg Adjustment	kN	l1	l2	ø l
8712-060	M6	180	12	7,5	5	+30 -35	11	6	10	5,5
8712-080	M8	214	13	10	6	+30 -40	16	8	10	6,5
8712-100	M10	238	15	11	8	+35 -50	26	9	12	8,5
8712-120	M12	308	25	14	12	+40 -60	31	13	20	12,5
8712-160	M16	388	31	22	14	+50 -70	69	20	23	14,5

Werkstoff 1.4401 | kN = Bruchkraft_Material AISI 316 | kN = breaking load

CS-GABEL MIT AUSSENGEWINDE_CS-FORK WITH EXTERNAL THREAD

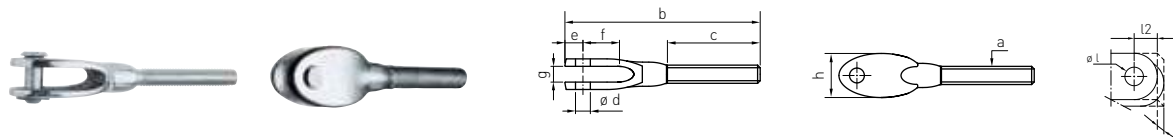

Artikelnummer Rechtsgewinde Part number RH thread	Artikelnummer Linksgewinde Part number LH thread	a	b	c	e	f	g	h	ø d	l1	l2	ø l
945-0600	946-0600	M6	77	35	7,5	14	6,5	20	6	6	9	6,5
945-0800	946-0800	M8	77	35	7,5	14	6,5	20	6	6	9	6,5
945-0801	946-0801	M8	106	50	10	19	8,5	24	8	8	12	8,5
945-1000	946-1000	M10	106	50	10	19	8,5	24	8	8	12	8,5

Werkstoff 1.4401 | CS-Gabel ist kompatibel mit CS-Öse_Material AISI 316 | CS-Fork is compatible with CS-Eye

CS-GABEL MIT INNENGEWINDE_CS-FORK WITH INTERNAL THREAD

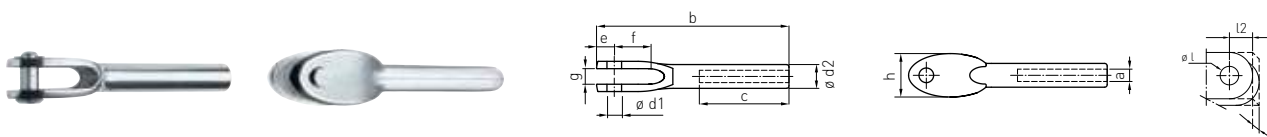

Artikelnummer Rechtsgewinde Part number RH thread	Artikelnummer Linksgewinde Part number LH thread	a	b	c	e	f	g	h	ø d1	ø d2	l1	l2	ø l
917-0500	918-0500	M5	78	40	7,5	14	6,5	20	6	10	6	9	6,5
917-0600	918-0600	M6	78	40	7,5	14	6,5	20	6	10	6	9	6,5
917-0800	918-0800	M8	78	40	7,5	14	6,5	20	6	10	6	9	6,5
917-0801	918-0801	M8	106	55	10	19	8,5	24	8	13	8	12	8,5
917-1000	918-1000	M10	106	55	10	19	8,5	24	8	13	8	12	8,5

Werkstoff 1.4401 | CS-Gabel ist kompatibel mit CS-Öse_Material AISI 316 | CS-Fork is compatible with CS-Eye

GABEL MIT INNENGEWINDE_FORK WITH INTERNAL THREAD

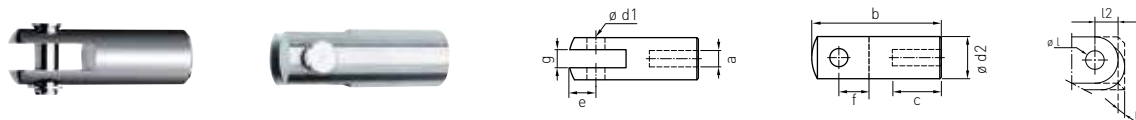

Artikelnummer Rechtsgewinde Part number RH thread	Artikelnummer Linksgewinde Part number LH thread	a	b	c	e	f	g	ø d1	ø d2	l1	l2	ø l
817-0500	818-0500	M5	36	13	8	9	5	5	12	4,5	8	5,5
817-0600	818-0600	M6	43	18	9	10	6	6	14	5,5	9	6,5
817-0800	818-0800	M8	54	24	12	12,5	7	8	18	6	12	8,5
817-1000	818-1000	M10	69	30	15	15	8	10	22	7	14	10,5
817-1200	818-1200	M12	81	36	17	18	10	12	26	9	16	12,5
817-1600	818-1600	M16	100	40	22	22	12	16	34	10	20	16,5
817-2000	818-2000	M20	122	40	27	27	15	20	42	13	25	20,5
817-2400	818-2400	M24	150	40	34	34	18	22	52	16	32	22,5

Werkstoff 1.4401 | Gabel mit Innengewinde ist kompatibel mit Öse mit Innengewinde

Material AISI 316 | Fork with internal thread is compatible with eye with internal thread

GABEL, VERPRESST_FORK, SWAGED

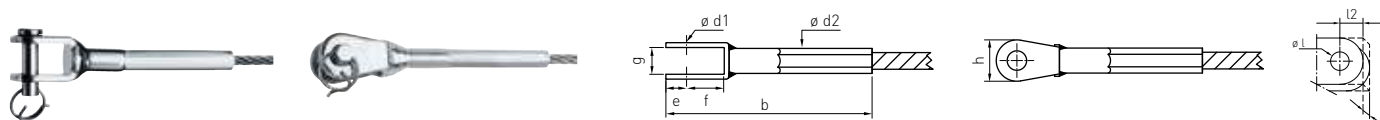

Artikelnummer Part number	b	e	f	g	h	ø d1	ø d2	ø Seil ø rope	kN	l1	l2	ø l
881-0200	65	6	12	7,5	12,5	5	5,5	2	2,9	6	10	5,5
881-0300	70	6	12	7,5	12,5	5	6,3	3	6,6	6	10	5,5
881-0400	80	7	13	10	14,5	6	7,5	4	9,5	8	10	6,5
881-0401	77	6	12	7,5	12,5	5	7,5	4	9,5	6	10	5,5
881-0500	93	9	15	11	17,5	8	9	5	14,5	9	12	8,5
881-0501	87,5	7,5	13	9,5	14,5	6	9	5	14,5	8	10	6,5
881-0600	112	11	20	12	20,5	9,5	12,5	6	23,5	9	16	10
881-0601	106,5	9,5	15	11	17,5	8	12,5	6	23,5	9	12	8,5
881-0800	143	14	25	14	26	12	16	8	31,5	13	20	12,5
881-1000	167	18	31	22	34	14	17,8	10	62	20	23	14,5
881-1200	205	18	31	22	34	16	20	12	87	20	23	16,5
881-1201	227	22	38	24	42	19	20	12	87	21	30	19,5
881-1600	309	28	48	30	42	25,4	28	16	142	28	46	26

Werkstoff 1.4401 | kN = Bruchkraft_Material AISI 316 | kN = breaking load

CS-GABEL, VERPRESST_CS-FORK, SWAGED

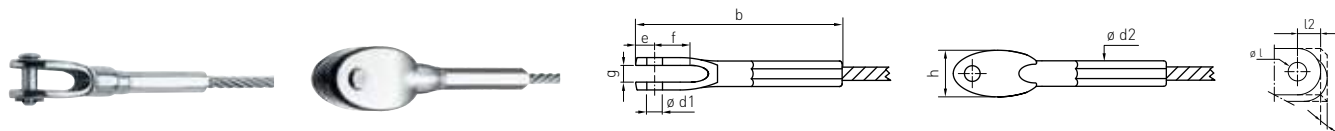

Artikelnummer Part number	b	e	f	g	h	ø d1	ø d2	ø Seil ø rope	kN	l1	l2	ø l
947-0400	78	7,5	14	6,5	20	6	7,8	4	11,8	6	9	6,5
947-0500	78	7,5	14	6,5	20	6	7,8	5	12	6	9	6,5
947-0600	106	10	19	8,5	24	8	9,8	6	16,5	8	12	8,5

Werkstoff 1.4401 | kN = Bruchkraft_Material AISI 316 | kN = breaking load

GABELFITTING, AUFGEROLLT_FORK, ROLL SWAGED

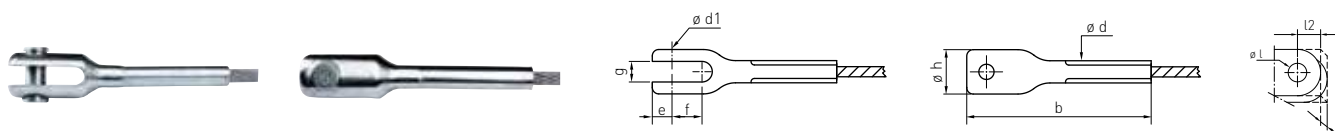

Artikelnummer Part number	b	e	f	g	ø h	ø d	ø d1	ø Seil ø rope	l1	l2	ø l
681-0600	116	14	18	10	22	12,5	10	6	8	17	10,3
681-0800	151	16	24	12	28	16,1	12	8	10	20	12,3
681-1000	185	20	29	14	34	17,8	16	10	12	26	16,3
681-1200	220	25	35	17	41	21,4	20	12	15	33	20,3
681-1400	238	28	41	20	48	24,9	23	14	18	38	23,3
681-1600	286	33	48	22	55	28	26	16	20	42	26,3
681-1800	335	38	53	28	70	34,5	29	18	25	48	29,3
681-2200	379	40	61	30	72	40,3	33	22	25	56	33,3
681-2600	445	45	71	33	83	45,9	36	26	30	60	36,3

Werkstoff 1.4404 | Europäische Technische Zulassung erteilt | Bruchkraft siehe Kapiteleinstieg "Zulassungen"

Material AISI 316L | European Technical Approval granted | for breaking load see introduction of the chapter "Approvals"

CS-GABEL MIT INNENGEWINDE, VERPRESST_CS-FORK WITH INTERNAL THREAD SWAGED

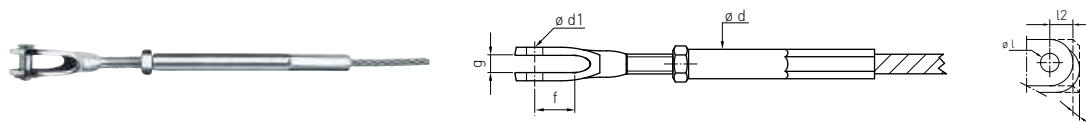

Artikelnummer Rechtsgewinde Part number RH thread	Artikelnummer Linksgewinde Part number LH thread	ø Seil ø rope	Gewinde Thread	Spannweg Adjustment	f	g	ø d	ø d1	l1	l2	ø l	kN
306-0400	307-0400	4	M6	+7 -11	14	6,5	8	6	6	9	6,5	8,9
306-0500	307-0500	5	M6	+7 -11	14	6,5	8	6	6	9	6,5	14
306-0600	307-0600	6	M8	+11 -21	19	8,5	10	8	8	12	8,5	20
306-0800	307-0800	8	M10	+11 -21	19	8,5	13	8	8	12	8,5	35

kN = Bruchkraft_kN = breaking load

BW-GABELVERSCHRAUBUNG_BW-FORK SWAGELESS CONNECTION

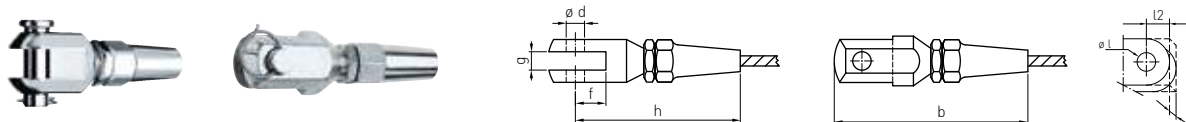

Artikelnummer Part number	b	f	g	h	ø d	ø Seil ø rope	kN	l1	l2	ø l
754-0300	63	11	6	55	6	3	7	5	9	6,5
754-0400	73	12	8	62	8	4	13	6	11	8,5
754-0500	83	15	10	72	10	5	20	8	14	10,5
754-0600	95	15	12	82	12	6	29	10	14	12,5
754-0800	118	21	14	103	14	8	52	12	19	14,5
754-1000	133	24	16	115	16	10	82	14	22	16,5
754-1200	157	27	18	137	19	12	118	16	25	19,5

Werkstoff 1.4401 | kN = Bruchkraft_Material AISI 316 | kN = breaking load

GABEL MIT INNENGEWINDE, VERPRESST_FORK WITH INTERNAL THREAD, SWAGED



Artikelnummer Rechtsgewinde Part number RH thread	Artikelnummer Linksgewinde Part number LH thread	a	b	f	g	ø d	ø d1	ø Seil ø rope	Spannweg Adjustment	kN	l1	l2	ø l
812-0300-01	811-0300-01	M5	100	12	7,5	7	5	3	+5 -10	6,7	6	10	5,5
812-0300-02	811-0300-02	M5	136	12	7,5	7	5	3	+12 -17	6,7	6	10	5,5
812-0400-01	811-0400-01	M6	106	12	7,5	8	5	4	+4 -10	9,5	6	10	5,5
812-0400-02	811-0400-02	M6	135	12	7,5	8	5	4	+11 -17	9,5	6	10	5,5
812-0500-01	811-0500-01	M6	110	12	7,5	8	5	5	+4 -10	12	6	10	5,5
812-0500-02	811-0500-02	M6	145	12	7,5	8	5	5	+11 -17	12	6	10	5,5
812-0600-01	811-0600-01	M8	135	13	10	10	6	6	+4 -12	16,5	8	10	6,5
812-0600-02	811-0600-02	M8	173	13	10	10	6	6	+17 -25	16,5	8	10	6,5
812-0800-01	811-0800-01	M10	248	15	11	13	8	8	+17 -27	26	9	12	8,5
812-1000-01	811-1000-01	M14	295	25	14	20	12	10	+26 -40	62	13	20	12,5
812-1200-01	811-1200-01	M16	345	31	22	24	14	12	+26 -42	77	20	23	14,5
812-1600-01	811-1600-01	M20	410	42	24	30	18	16	+30 -50	133	22	32	19,5

Werkstoff 1.4401 | kN = Bruchkraft_Material AISI 316 | kN = breaking load

SPANNSCHLOSS MIT GABEL, VERPRESST_TURNBUCKLE WITH FORK, SWAGED



Artikelnummer Part number	a	b	f	g	ø d	ø d1	ø Seil ø rope	Spannweg Adjustment	kN	l1	l2	ø l
870-0200	M5	190	12	7,5	5	5	2	+26 -43	2,9	6	10	5,5
870-0300	M6	220	12	7,5	6	5	3	+28 -50	6,6	6	10	5,5
870-0400	M6	225	12	7,5	7	5	4	+28 -50	11,5	6	10	5,5
870-0401	M8	248	13	10	8	6	4	+34 -50	11,8	8	10	6,5
870-0500	M8	254	13	10	8	6	5	+34 -50	18,5	8	10	6,5
870-0600	M10	283	15	11	10	8	6	+30 -50	26,7	9	12	8,5
870-0800	M12	368	25	14	13	12	8	+46 -70	31,5	13	20	12,5
870-1000	M16	490	31	22	18	14	10	+48 -90	69,4	20	23	14,5
870-1200	M20	580	42	24	20	19	12	+60 -105	93,6	22	32	19,5
870-1600	M24	680	50	30	27	25	16	+90 -120	133	28	46	26

Werkstoff 1.4401 | kN = Bruchkraft_Material AISI 316 | kN = breaking load

SPANNSCHLOSS MIT GABEL, GEHÄMMERT_TURNBUCKLE WITH FORK, HAMMERED

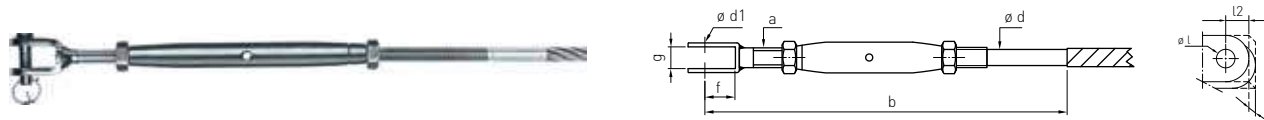

Artikelnummer Part number	a	b	f	g	ø d±0,2	ø d1	ø Seil ø rope	Spannweg Adjustment	kN	l1	l2	ø l
870-0400-F30	M5	165	12	7,5	5	5	4	+30 -35	7	6	10	5,5
870-0500-F30	M6	186	12	7,5	6	5	5	+30 -40	11	6	10	5,5
870-0600-F30	M8	221	13	10	8	6	6	+35 -50	16	8	10	6,5
870-0800-F30	M10	247	15	11	10	8	8	+40 -60	25	9	12	8,5
870-1000-F30	M12	305	25	14	12	12	10	+50 -70	41	13	20	12,5

Werkstoff 1.4404 | Nicht geeignet für Spiralseile 1x19 | kN = Bruchkraft_Material AISI 316L | Not suitable for strands 1x19 | kN = breaking load

SPANNSCHLOSS MIT GABEL, VERSCHRAUBT_TURNBUCKLE WITH FORK SWAGELESS

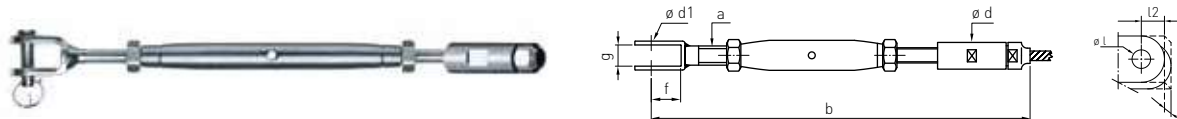

Artikelnummer Part number	a	b	f	g	ø d	ø d1	ø Seil ø rope	Spannweg Adjustment	kN	l1	l2	ø l
870-0400-827	M6	221	12	7,5	13	5	4	+40 -42	7	6	10	5,5
870-0500-827	M8	247	13	10	15	6	5	+40 -50	12	8	10	6,5
870-0600-827	M8	247	13	10	15	6	6	+40 -50	18	8	10	6,5
870-0800-827	M10	300	15	11	20	8	8	+50 -50	31	9	12	8,5

Werkstoff 1.4401 | kN = Bruchkraft_Material AISI 316 | kN = breaking load

SPANNSCHLOSS MIT GABELFITTING_TURNBUCKLE WITH FORK FITTING



Artikelnummer Part number	a	b	e	f	g	ø d	ø d1	ø Seil ø rope	Spannweg Adjustment	l1	l2	ø l
670-0600	M10	231	14	18	10	12,5	10	6	+13 -43	8	17	10,3
670-0800	M12	307	16	24	12	16,1	12	8	+22 -58	10	20	12,3
670-1000	M14	346	20	29	14	17,8	16	10	+31 -73	12	26	16,3
670-1200	M16	458	25	35	17	21,4	20	12	+39 -87	15	33	20,3
670-1400	M20	535	28	41	20	24,9	23	14	+46 -106	18	38	23,3
670-1600	M24	644	33	48	22	28	26	16	+60 -126	20	42	26,3
670-1800	M27	712	38	53	28	34,5	29	18	+54 -135	25	48	29,3
670-2200	M30	850	40	61	30	40,3	33	22	+74 -164	25	56	33,3
670-2600	M36	913	45	71	33	45,9	36	26	+56 -164	30	60	36,3

Werkstoff 1.4404 | Europäische Technische Zulassung erteilt | Bruchkraft siehe Kapiteleinstieg "Zulassungen"

Material AISI 316L | European Technical Approval granted | for breaking load see introduction of the chapter "Approvals"

CS GABEL MIT AUSSENGEWINDE, GEHÄMMERT_CS-FORK WITH EXTERNAL THREAD, HAMMERED

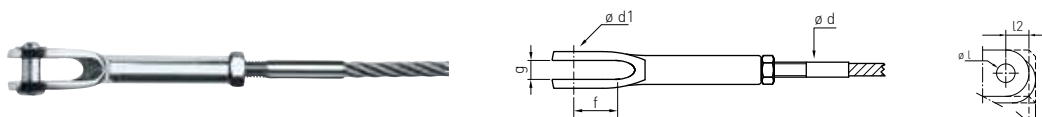

Artikelnummer Rechtsgewinde Part number RH thread	Artikelnummer Linksgewinde Part number LH thread	ø Seil ø rope	Gewinde Thread	Spannweg Adjustment	f	g	ø d ^{+0,2} ₀	ø d1	l1	l2	ø l	kN
346-0400	345-0400	4	M5	+15 -17	14	6,5	5	6	6	9	6,5	8,9
346-0500	345-0500	5	M6	+15 -17	14	6,5	6	6	6	9	6,5	14
346-0600	345-0600	6	M8	+15 -24	19	8,5	8	8	8	12	8,5	20
346-0800	345-0800	8	M10	+15 -24	19	8,5	10	8	8	12	8,5	35

Werkstoff 1.4404 | Nicht geeignet für Spiralseile 1x19 | kN = Bruchkraft_Material AISI 316L | Not suitable for strands 1x19 | kN = breaking load

ALLE ANGABEN IN MILLIMETERN_ALL DIMENSIONS IN MILLIMETRES

KONFEKTIONEN: GABELN

ASSEMBLY DRAWINGS: FORKS

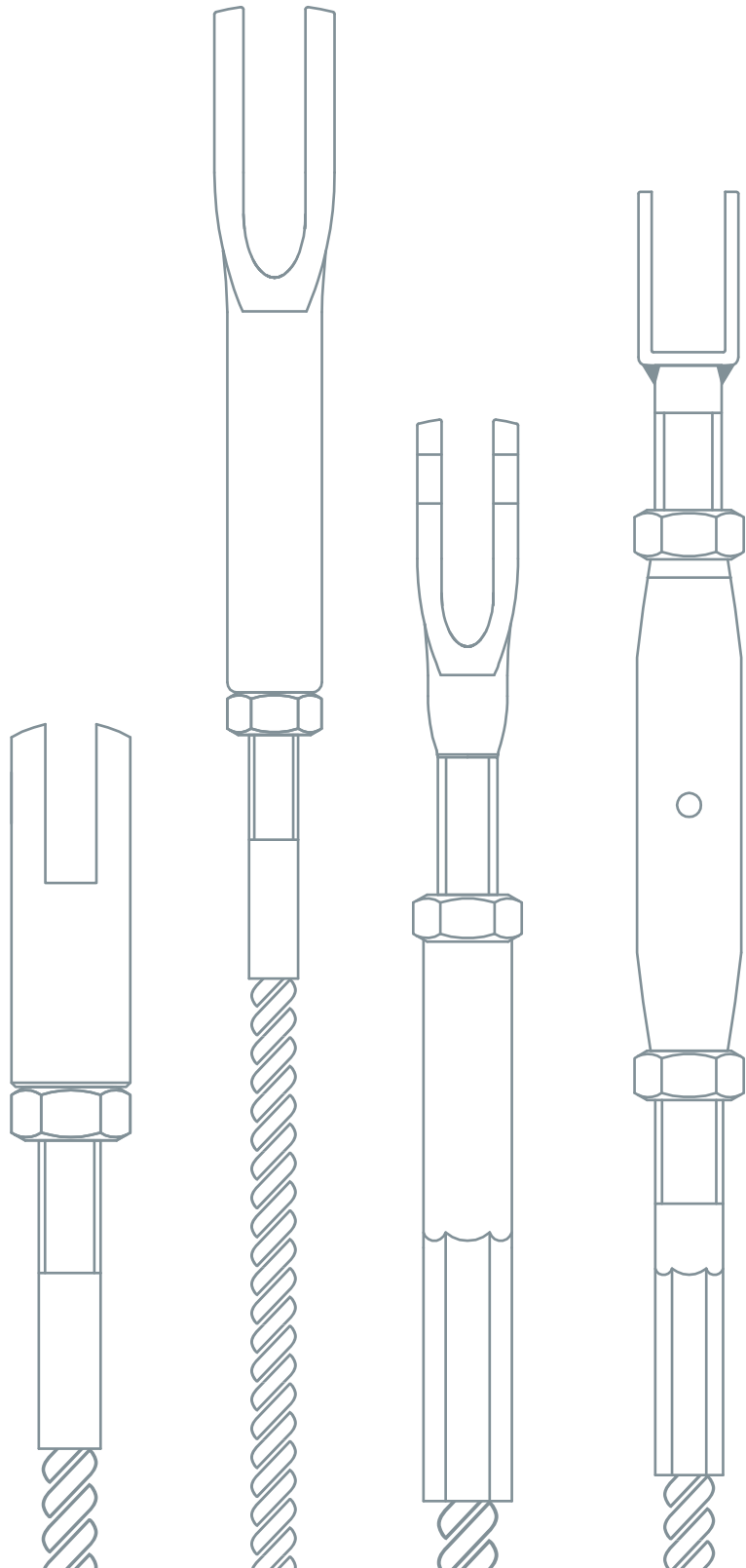

BEIDE SEITEN GABEL MIT INNENGEWINDE, VERPRESST_BOTH SIDES FORK WITH INTERNAL THREAD SWAGED

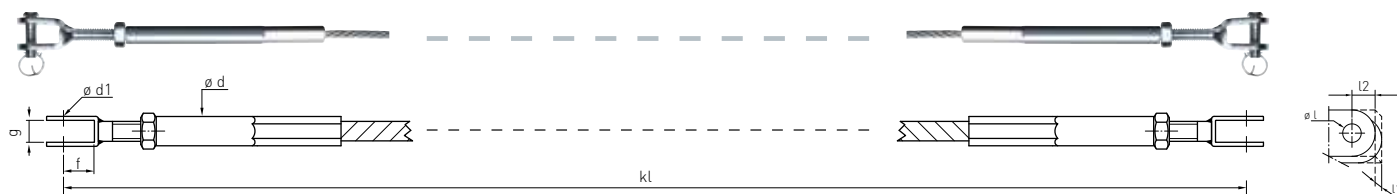

Artikelnummer Part number	\varnothing Seil \varnothing rope	Sk	Gewinde Thread	Spannweg Adjustment	f	g	$\varnothing d$	$\varnothing d1$	kl min	l1	l2	$\varnothing l$	kN
IK 300-0300	3	7 x 7	M5	+10 -20	12	7,5	7	5	250	6	10	5,5	5
IK 300-0301	3	7 x 7	M5	+24 -34	12	7,5	7	5	320	6	10	5,5	5
IK 300-0400	4	7 x 7	M6	+8 -20	12	7,5	8	5	270	6	10	5,5	8,9
IK 300-0401	4	7 x 7	M6	+22 -34	12	7,5	8	5	320	6	10	5,5	8,9
IK 300-0500	5	7 x 7	M6	+8 -20	12	7,5	8	5	270	6	10	5,5	14
IK 300-0501	5	7 x 7	M6	+22 -34	12	7,5	8	5	340	6	10	5,5	14
IK 300-0600	6	7 x 7	M8	+8 -24	13	10	10	6	320	8	10	6,5	20
IK 300-0601	6	7 x 7	M8	+34 -50	13	10	10	6	400	8	10	6,5	20
IK 300-0800	8	7 x 7	M10	+34 -54	15	11	13	8	570	9	12	8,5	35
IK 300-1000	10	7 x 19	M14	+52 -80	25	14	20	12	700	13	20	12,5	52
IK 300-1200	12	7 x 19	M16	+52 -84	31	22	24	14	820	20	23	14,5	75
IK 300-1600	16	7 x 19	M20	+60 -100	42	24	30	19	1000	22	32	20	133

kN = Bruchkraft_kN = breaking load

BEIDE SEITEN CS-GABEL MIT INNENGEWINDE, VERPRESST_BOTH SIDES CS-FORK WITH INTERNAL THREAD SWAGED

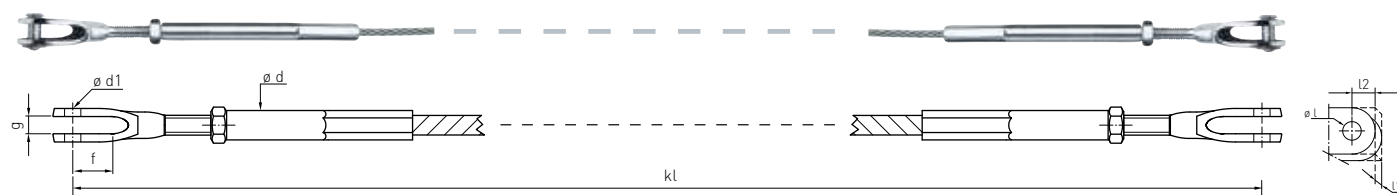

Artikelnummer Part number	\varnothing Seil \varnothing rope	Sk	Gewinde Thread	Spannweg Adjustment	f	g	$\varnothing d$	$\varnothing d1$	kl min	l1	l2	$\varnothing l$	kN
IK 305-0400	4	7 x 7	M6	+14 -22	14	6,5	8	6	320	6	9	6,5	8,9
IK 305-0500	5	7 x 7	M6	+14 -22	14	6,5	8	6	340	6	9	6,5	14
IK 305-0600	6	7 x 7	M8	+22 -42	19	8,5	10	8	450	8	12	8,5	20
IK 305-0800	8	7 x 7	M10	+22 -42	19	8,5	13	8	570	8	12	8,5	35

kN = Bruchkraft_kN = breaking load

EINE SEITE SPANNSCHLOSS MIT GABEL, ANDERE SEITE GABEL, VERPRESST
ONE SIDE TURNBUCKLE WITH FORK, OTHER SIDE WITH FORK SWAGED

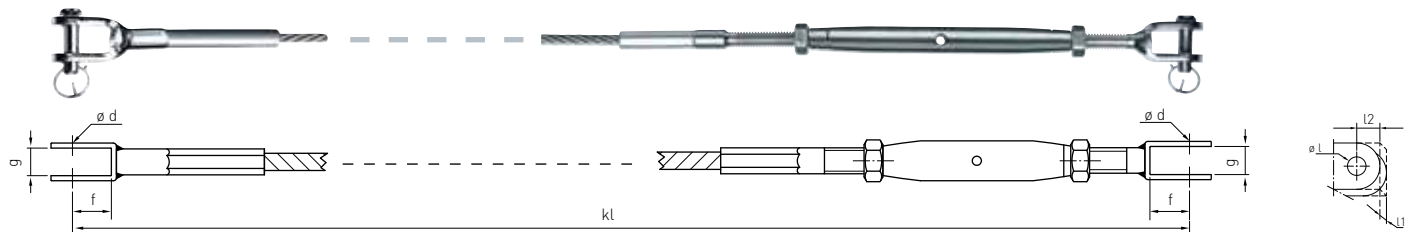

Artikelnummer Part number	ø Seil ø rope	Sk	Gewinde Thread	Spannweg Adjustment	f	g	ø d	kl min	l1	l2	ø l	kN
IK 310-0200	2	7 x 7	M5	+26 -43	12	7,5	5	220	6	10	5,5	2,2
IK 310-0300	3	7 x 7	M6	+28 -50	12	7,5	5	240	6	10	5,5	5
IK 310-0400	4	7 x 7	M6	+28 -50	12	7,5	5	350	6	10	5,5	8,9
IK 310-0401	4	7 x 7	M8	+34 -50	13	10	6	380	8	10	6,5	8,9
IK 310-0500	5	7 x 7	M8	+34 -50	13	10	6	400	8	10	6,5	14
IK 310-0600	6	7 x 7	M10	+30 -50	15	11	8	460	9	12	8,5	20
IK 310-0800	8	7 x 7	M12	+46 -70	25	14	12	600	13	20	12,5	35
IK 310-1000	10	7 x 19	M16	+48 -90	31	22	14	750	20	23	14,5	52
IK 310-1200	12	7 x 19	M20	+60 -105	31	24	19	900	22	30	19,5	75
IK 310-1600	16	7 x 19	M24	+90 -120	42	30	25	1200	28	46	26	133

kN = Bruchkraft_kN = breaking load

BEIDE SEITEN SPANNSCHLOSS MIT GABEL, VERPRESST_BOTH SIDES TURNBUCKLE WITH FORK SWAGED

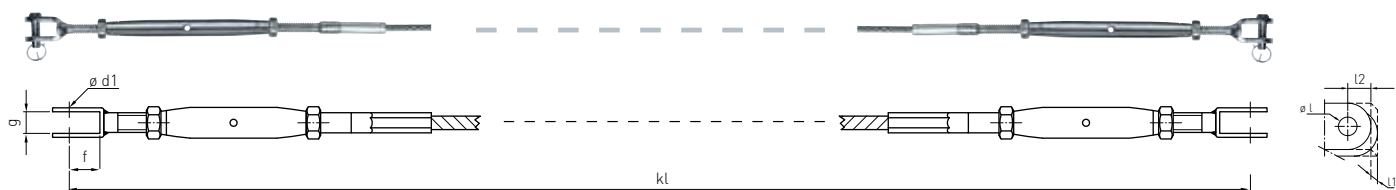

Artikelnummer Part number	ø Seil ø rope	Sk	Gewinde Thread	Spannweg Adjustment	f	g	ø d1	kl min	l1	l2	ø l	kN
IK 320-0200	2	7 x 7	M5	+52 -86	12	7,5	5	345	6	10	5,5	2,2
IK 320-0300	3	7 x 7	M6	+56 -100	12	7,5	5	390	6	10	5,5	5
IK 320-0400	4	7 x 7	M6	+56 -100	12	7,5	5	500	6	10	5,5	8,9
IK 320-0401	4	7 x 7	M8	+68 -100	13	10	6	550	8	10	6,5	8,9
IK 320-0500	5	7 x 7	M8	+68 -100	13	10	6	560	8	10	6,5	14
IK 320-0600	6	7 x 7	M10	+60 -100	15	11	8	630	9	12	8,5	20
IK 320-0800	8	7 x 7	M12	+92 -140	25	14	12	820	13	20	12,5	35
IK 320-1000	10	7 x 19	M16	+96 -180	32	22	14	1100	20	23	14,5	52
IK 320-1200	12	7 x 19	M20	+120 -210	42	24	19	1300	22	30	19,5	75
IK 320-1600	16	7 x 19	M24	+180 -240	42	30	25	1600	28	46	26	133

kN = Bruchkraft_kN = breaking load

BEIDE SEITEN MIT AUSSENGEWINDE F30 UND AUFGEDREHTER GABEL MIT INNENGEWINDE
BOTH SIDES WITH EXTERNAL THREAD F30 COMPLETE WITH FORK WITH INTERNAL THREAD

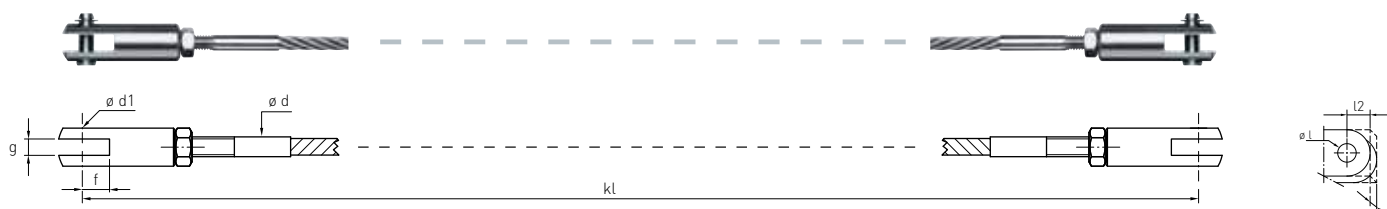

Artikelnummer Part number	Ø Seil Ø rope	Sk	Gewinde Thread	Spannweg Adjustment	f	g	$\varnothing d_{+0,2}^0$	$\varnothing d1$	kl min	l1	l2	Ø l	kN
IK 340-0400	4	7 x 7	M5	+6 l -14	9	5	5	5	290	4,5	8	5,5	7,1
IK 340-0500	5	7 x 7	M6	+6 l -18	10	6	6	6	300	5,5	9	6,5	11
IK 340-0600	6	7 x 7	M8	+8 l -30	12,5	7	8	8	320	6	12	8,5	16
IK 340-0800	8	7 x 7	M10	+10 l -44	15	8	10	10	350	7	14	10,5	25
IK 340-1000	10	7 x 19	M12	+16 l -40	18	10	12	12	470	9	16	12,5	41

kN = Bruchkraft_ kN = breaking load

BEIDE SEITEN MIT AUSSENGEWINDE F30 UND AUFGEDREHTER CS-GABEL MIT INNENGEWINDE
BOTH SIDES WITH EXTERNAL THREAD F30 COMPLETE WITH CS-FORK WITH INTERNAL THREAD

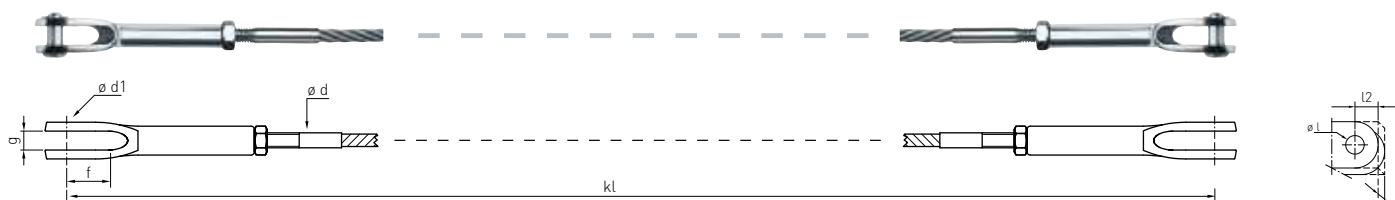

Artikelnummer Part number	Ø Seil Ø rope	Sk	Gewinde Thread	Spannweg Adjustment	f	g	$\varnothing d_{+0,2}^0$	$\varnothing d1$	kl min	l1	l2	Ø l	kN
IK 345-0400	4	7 x 7	M5	+29 l -34	14	6,5	5	6	356	6	9	6,5	8,9
IK 345-0500	5	7 x 7	M6	+29 l -34	14	6,5	6	6	356	6	9	6,5	14
IK 345-0600	6	7 x 7	M8	+30 l -49	19	8,5	8	8	426	8	12	8,5	20
IK 345-0800	8	7 x 7	M10	+30 l -49	19	8,5	10	8	426	8	12	8,5	35

kN = Bruchkraft_ kN = breaking load

MONTAGEBEISPIELE

INSTALLATION EXAMPLES

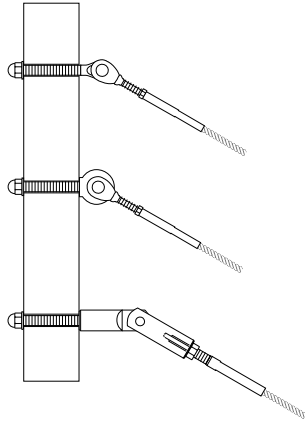

Beispiel 1_Example 1

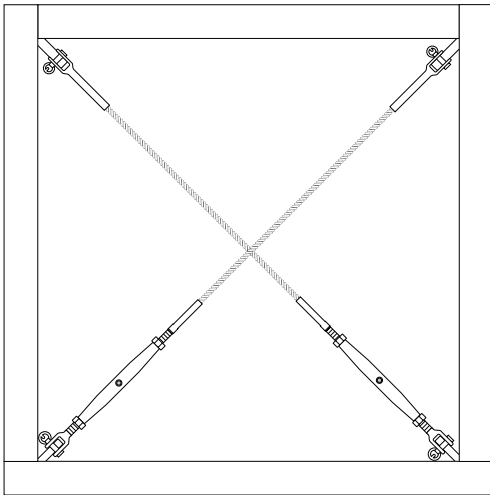

Beispiel 3_Example 3

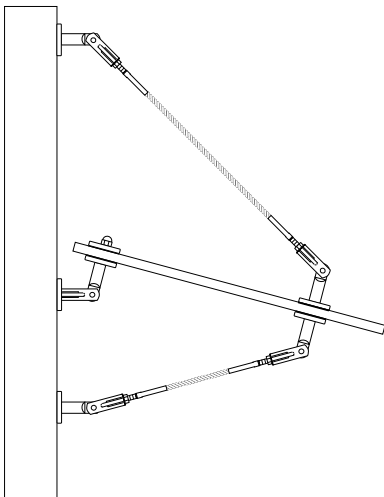

Beispiel 5_Example 5

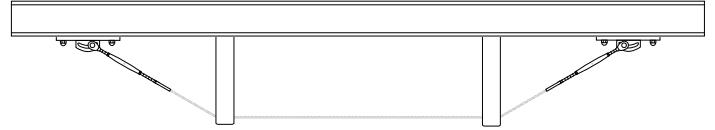

Beispiel 2_Example 2



Beispiel 4_Example 4

<p>Beispiel 1 Example 1</p>	<p>Beispiele für die Kombination von Ösen und Gabeln. Examples for combinations with eyes and forks.</p>
<p>Beispiel 2 Example 2</p>	<p>Die Seilkonfektionen mit Spannschloss und Gabel an beiden Seiten eignen sich für unterspannte Träger. The cable assemblies with turnbuckle and forks on both sides are suitable for truss arrangements.</p>
<p>Beispiel 3 Example 3</p>	<p>Zur Aussteifung sind mit Spannschloss an einer Seite ausgestattete Konfektionen sinnvoll. Cable assemblies with turnbuckle on one side are useful for bracing.</p>
<p>Beispiel 4 Example 4</p>	<p>Die Seilkonfektionen aus Gabeln mit Innengewinde, verpresst, sind eine filigrane und wirtschaftliche Alternative zu Spannschlössern mit Gabeln. Cable assemblies made of forks with swaged internal threads provide a symmetrical and cost-effective alternative to turnbuckles.</p>
<p>Beispiel 5 Example 5</p>	<p>Die Kombination von Gabeln und Ösen erlaubt frei einstellbare Winkelanschlüsse. Combination of forks and eyes allow angled connections to be freely selected.</p>

ZIELSICHER ÜBER ECKEN UND KANTEN AROUND CORNERS AND OVER EDGES

Als Gegenstück zu den Gabeln ergänzen Ösen das Duett zum dauerhaften Detail. Stark verbunden und dennoch gelenkig führt diese Art der Koppelung sogar um die Ecke. Auf sich allein gestellt können Ösen auch zur Führung von Seilen oder zur Verankerung im Bauwerk dienen.

As a counterpart to the forks, eyes complete the pair as regards detailed design and long lifetime. Offering a strong connection, yet also flexibly jointed, this type of coupling even goes around corners. Applied alone, eyes can also be used to guide cables or for anchorage within the shell of the building.



**Merkmale**
Attributes

- **Passende Ösenoptik für alle Gabelformen**
- **Kleine Bauarten ermöglichen transparente Lösungen**
- **Große Auswahl**
- Eye designs to match any fork geometry
- Small sizes permit transparent solutions
- Large choice available

KOMPONENTEN

COMPONENTS

ÖSE-GEGENSTÜCK_EYE COUNTERPIECE



Artikelnummer Part number	a	b	c	f1	f2	g	ø d1	ø d2
887-0800	M8	72	48	6,5	16	5	13	5

Werkstoff 1.4401_Material AISI 316

ÖSE MIT AUSSENGEWINDE_EYE WITH EXTERNAL THREAD



Artikelnummer Rechtsgewinde Part number RH thread	Artikelnummer Linksgewinde Part number LH thread	a	b	c	e	f	h	k	ø d
885-0500	886-0500	M5	14	41	6	63	12	3	5,5
885-0500-01	886-0500-01	M5	15	25	6	46	12	3	5,5
885-0600	886-0600	M6	16	47	7	61	14	4	6,5
885-0600-01	886-0600-01	M6	16	30	7	44	14	4	6,5
885-0800	886-0800	M8	21	57	8,5	78	17	5	8,5
885-0800-01	886-0800-01	M8	21	35	9,5	55,5	17	5	8,5
885-1000	886-1000	M10	29	63	12	90	22	6	10,5
885-1200	886-1200	M12	31	80	14	110	25	8	13
885-1400	886-1400	M14	34	90	14	124	28	9	13
885-1600	886-1600	M16	37	100	15,5	133	31	10	14,5
885-2000	886-2000	M20	49	120	21	164	40	15	19,5

Werkstoff 1.4401_Material AISI 316

CS-ÖSE MIT AUSSENGEWINDE_CS-EYE WITH EXTERNAL THREAD

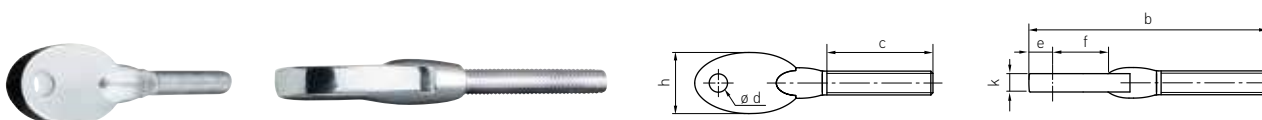

Artikelnummer Rechtsgewinde Part number RH thread	Artikelnummer Linksgewinde Part number LH thread	a	b	c	e	f	h	k	ø d
985-0600	986-0600	M6	78	32	8	19	20	6	6
985-0800	986-0800	M8	78	32	8	19	20	6	6
985-0801	986-0801	M8	106	47	10	23	24,5	8	8
985-1000	986-1000	M10	106	47	10	23	24,5	8	8

Werkstoff 1.4401 | CS-Öse ist kompatibel mit CS-Gabel_Material AISI 316 | CS-Eye is compatible with CS-Fork

ALLE ANGABEN IN MILLIMETERN_ALL DIMENSIONS IN MILLIMETRES

CS-ÖSE MIT INNENGEWINDE_CS-EYE WITH INTERNAL THREAD

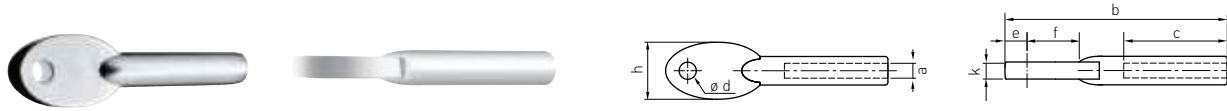

Artikelnummer Rechtsgewinde Part number RH thread	Artikelnummer Linksgewinde Part number LH thread	a	b	c	e	f	h	k	ø d
906-0500	907-0500	M5	78	40	8	19	20	6	6
906-0600	907-0600	M6	78	40	8	19	20	6	6
906-0800	907-0800	M8	78	40	8	19	20	6	6
906-0801	907-0801	M8	106	55	10	23	24,5	8	8
906-1000	907-1000	M10	106	55	10	23	24,5	8	8

Werkstoff 1.4401 | CS-Öse ist kompatibel mit CS-Gabel_Material AISI 316 | CS-Eye is compatible with CS-Fork

ÖSE MIT INNENGEWINDE_EYE WITH INTERNAL THREAD

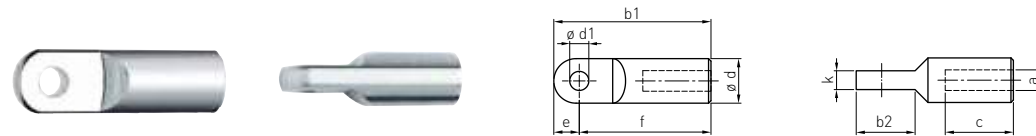

Artikelnummer Rechtsgewinde Part number RH thread	Artikelnummer Linksgewinde Part number LH thread	a	b1	b2	c	e	f	k	ø d1	ø d2
806-0500	807-0500	M5	39	16	16	7	32	4,9	5	12
806-0600	807-0600	M6	46	18,5	17	8	38	5,9	6	14
806-0800	807-0800	M8	62	24,5	25	10,5	51,5	6,9	8	18
806-1000	807-1000	M10	74	30	30	13	61	7,9	10	22
806-1200	807-1200	M12	88	35	35	15	73	9,9	12	26
806-1600	807-1600	M16	112	44	40	19	93	11,9	16	34
806-2000	807-2000	M20	140	55	40	24	116	14,9	20	42
806-2400	807-2400	M24	168	68	40	30	138	17,9	22	52

Werkstoff 1.4401_Material AISI 316

AUGENSCHRAUBE_EYE BOLT

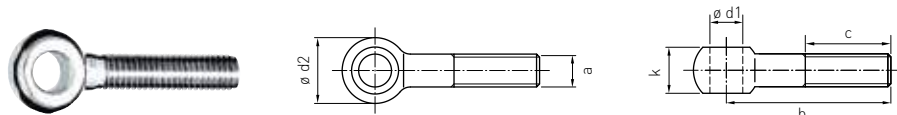

Artikelnummer Rechtsgewinde Part number RH thread	Artikelnummer Linksgewinde Part number LH thread	a	b	c	k	$\varnothing d1$	$\varnothing d2$
888-0600-03	888-0600-04	M6	40	30	7	6,1	14
888-0800-03	888-0800-04	M8	40	30	9	8,1	18
888-1000-03	888-1000-04	M10	50	40	12	10	20
888-1200-03	888-1200-04	M12	50	35	14	12,1	25
888-1600-03	888-1600-04	M16	60	40	17	16,1	32
888-2000-03	888-2000-04	M20	80	55	22	18,1	40

Werkstoff 1.4301_Material AISI 304

CS-ÖSE, VERPRESST_CS-EYE, SWAGED

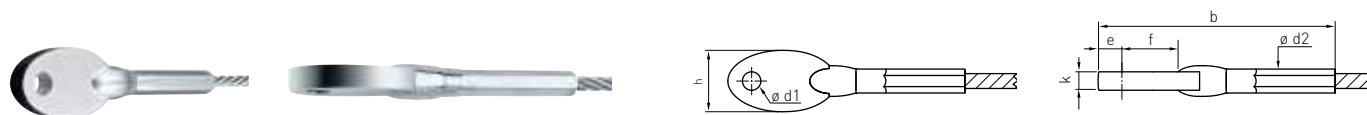

Artikelnummer Part number	b	e	k	f	h	$\varnothing d1$	$\varnothing d2$	\varnothing Seil \varnothing rope	kN
980-0400	78	8	6	19	20	7,8	6	4	11,8
980-0500	78	8	6	19	20	7,8	6	5	12
980-0600	106	10	8	23	24,5	9,8	8	6	16,5

Werkstoff 1.4401 | CS-Öse ist kompatibel zu CS-Gabel | kN = Bruchkraft

Material AISI 316 | CS-Eye is compatible with CS-Fork | kN = breaking load

ÖSE, VERPRESST_EYE, SWAGED

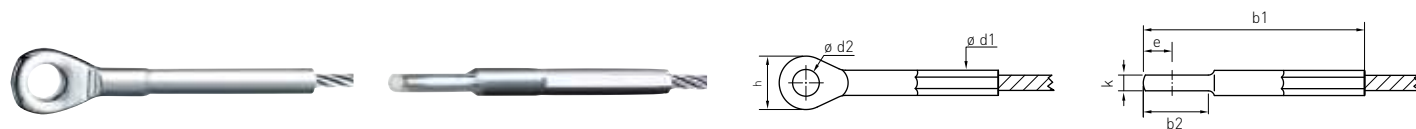

Artikelnummer Part number	b1	b2	e	h	k	$\varnothing d1$	$\varnothing d2$	\varnothing Seil \varnothing rope	kN
880-0200	57	16	6,5	12,5	3	5,5	5,5	2	2,9
880-0300	62	17	6,5	13,5	4	6,3	6,5	3	6,7
880-0400	77	22	9	17	5	7,5	8,5	4	11,9
880-0500	87	27	11	21	6	9	10,5	5	18,5
880-0600	108	29	12,5	25	8	12,5	13	6	26,7
880-0800	133	37	15	30	10	16	14,5	8	44,5
880-1000	159	45	18	35	11	17,8	16,3	10	69,5
880-1200	181	49	20	40	15	20	19,3	12	93,6
880-1600	245	72	31,7	44	24	28,2	25,5	16	133

Werkstoff 1.4401 | kN = Bruchkraft_Material AISI 316 | kN = breaking load

ALLE ANGABEN IN MILLIMETERN_ALL DIMENSIONS IN MILLIMETRES

SPANNSCHLOSS MIT ÖSE, VERPRESST_TURNBUCKLE WITH EYE SWAGED

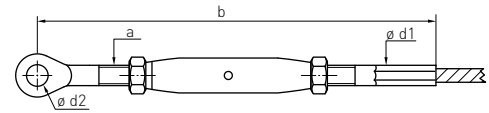

Artikelnummer Part number	a	b	ø d1	ø d2	ø Seil ø rope	Spannweg Adjustment	kN
889-0200	M5	193	5	5,5	2	+26 -43	2,9
889-0300	M6	220	6	6,5	3	+28 -50	6,7
889-0400	M6	220	7	6,5	4	+28 -50	11,9
889-0401	M8	248	8	8,5	4	+34 -50	11,9
889-0500	M8	254	8	8,5	5	+34 -50	18,5
889-0600	M10	288	10	10,5	6	+30 -50	26,7
889-0800	M12	368	13	13	8	+46 -70	44,5
889-1000	M16	490	18	14,5	10	+48 -90	69,4
889-1200	M20	570	20	19,5	12	+60 -105	93,6

Werkstoff 1.4401 | kN = Bruchkraft_Material AISI 316 | kN = breaking load

SPANNSCHLOSS MIT ÖSE, GEHÄMMERT_TURNBUCKLE WITH EYE HAMMERED

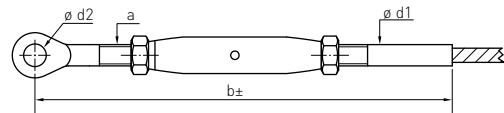

Artikelnummer Part number	a	b	ø d1 ^{+0,2} ₀	ø d2	ø Seil ø rope	Spannweg Adjustment	kN
889-0400-F30	M5	168	5	5,5	4	+30 -35	7
889-0500-F30	M6	180	6	6,5	5	+30 -40	11
889-0600-F30	M8	221	8	8,5	6	+35 -50	16
889-0800-F30	M10	247	10	10,5	8	+40 -60	25
889-1000-F30	M12	296	12	13	10	+50 -70	41

Werkstoff 1.4401 | kN = Bruchkraft_Material AISI 316 | kN = breaking load

CS-ÖSE MIT INNENGEWINDE, VERPRESST_CS-EYE WITH INTERNAL THREAD, SWAGED

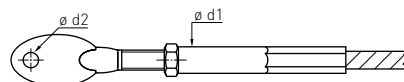

Artikelnummer Rechtsgewinde Part number RH thread	Artikelnummer Linksgewinde Part number LH thread	ø Seil ø rope	Spannweg Adjustment	ø d1	ø d2	kN
816-0400	815-0400	4	+7 -11	8	6	8,9
816-0500	815-0500	5	+7 -11	8	6	12
816-0600	815-0600	6	+11 -21	10	8	16
816-0800	815-0800	8	+11 -21	13	8	26

kN = Bruchkraft_kN = breaking load

ALLE ANGABEN IN MILLIMETERN_ALL DIMENSIONS IN MILLIMETRES

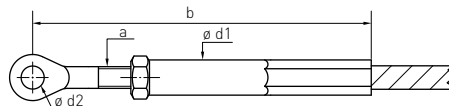
ÖSE MIT INNENGEWINDE, VERPRESST_EYE WITH INTERNAL THREAD, SWAGED

Artikelnummer Rechtsgewinde Part number RH thread	Artikelnummer Linksgewinde Part number LH thread	a	b	ø d1	ø d2	ø Seil ø rope	Spannwert Adjustment	kN
814-0300-01	813-0300-01	M5	100	7	5,5	3	+5 -10	6,7
814-0300-02	813-0300-02	M5	136	7	5,5	3	+12 -17	6,7
814-0400-01	813-0400-01	M6	106	8	6,5	4	+4 -10	11,8
814-0400-02	813-0400-02	M6	135	8	6,5	4	+11 -17	11,8
814-0500-01	813-0500-01	M6	110	8	6,5	5	+4 -10	12
814-0500-02	813-0500-02	M6	145	8	6,5	5	+11 -17	12
814-0600-01	813-0600-01	M8	135	10	8,5	6	+4 -12	16,5
814-0600-02	813-0600-02	M8	173	10	8,5	6	+17 -25	16,5
814-0800-01	813-0800-01	M10	248	13	10,5	8	+17 -27	26
814-1000-01	813-1000-01	M14	295	20	13	10	+26 -40	69,5
814-1200-01	813-1200-01	M16	345	24	14,5	12	+26 -40	93,6
814-1600-01	813-1600-01	M20	410	30	19,3	16	+30 -50	133

Werkstoff 1.4401 | kN = Bruchkraft_Material AISI 316 | kN = breaking load

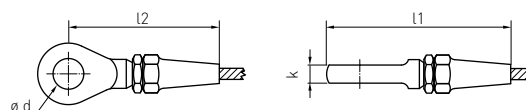
BW-ÖSENVERSCHRAUBUNG_ BW-EYE SWAGELESS CONNECTION

Artikelnummer Part number	k	l1	l2	ø d	ø Seil ø rope	kN
753-0300	5,5	58	50	6,3	3	7
753-0400	7	68	58	8,3	4	13
753-0500	8	81	70	10,3	5	20
753-0600	9	97	83	12,3	6	29
753-0800	10,5	121	103	14,3	8	52
753-1000	13	133	114	16,3	10	82
753-1200	15	155	132	19,5	12	118

Werkstoff 1.4401 | kN = Bruchkraft_Material AISI 316 | kN = breaking load

KONFEKTIONEN: ÖSEN

ASSEMBLY DRAWINGS: EYES

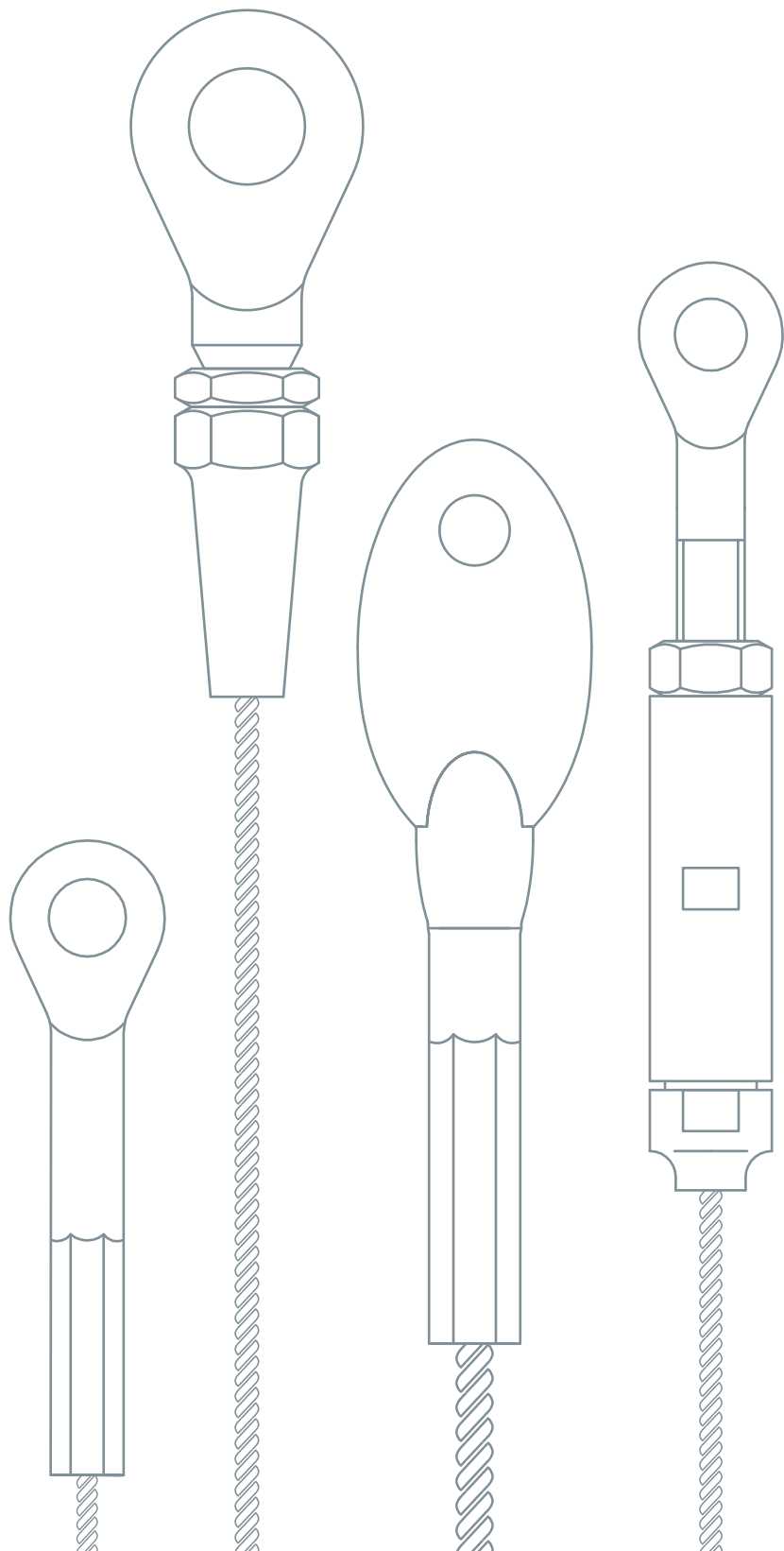

BEIDE SEITEN ÖSEN MIT INNENGEWINDE, VERPRESST_BOTH SIDES EYE WITH INTERNAL THREAD, SWAGED

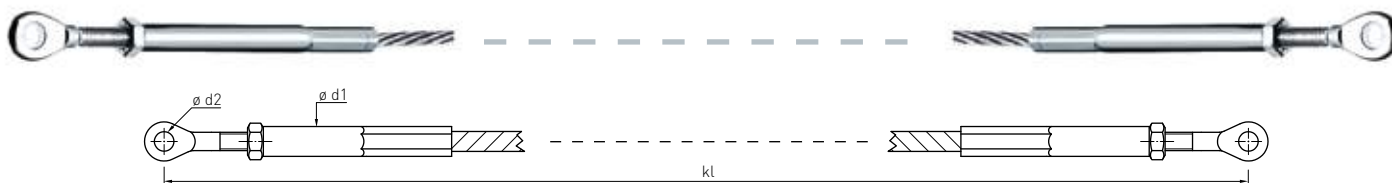

Artikelnummer Part number	\varnothing Seil \varnothing rope	Sk	Gewinde Thread	Spannweg Adjustment	$\varnothing d1$	$\varnothing d2$	kl min	kN
IK 400-0300	3	7 x 7	M5	+10 -20	7	5,5	250	5
IK 400-0301	3	7 x 7	M5	+24 -20	7	5,5	304	5
IK 400-0400	4	7 x 7	M6	+8 -20	8	6,5	233	8,9
IK 400-0401	4	7 x 7	M6	+22 -34	8	6,5	299	8,9
IK 400-0500	5	7 x 7	M6	+8 -20	8	6,5	248	12
IK 400-0501	5	7 x 7	M6	+22 -34	8	6,5	324	12
IK 400-0600	6	7 x 7	M8	+8 -20	10	8,5	316	16
IK 400-0601	6	7 x 7	M8	+34 -50	10	8,5	398	16
IK 400-0800	8	7 x 7	M10	+52 -54	13	10,5	556	26
IK 400-1000	10	7 x 19	M14	+52 -80	20	13	598	69
IK 400-1200	12	7 x 19	M16	+52 -54	25	14,5	706	75
IK 400-1600	16	7 x 19	M20	+60 -100	32	19,3	868	133

kN = Bruchkraft_kN = breaking load

BEIDE SEITEN CS-ÖSE MIT INNENGEWINDE, VERPRESST_BOTH SIDES CS-EYE WITH INTERNAL THREAD, SWAGED

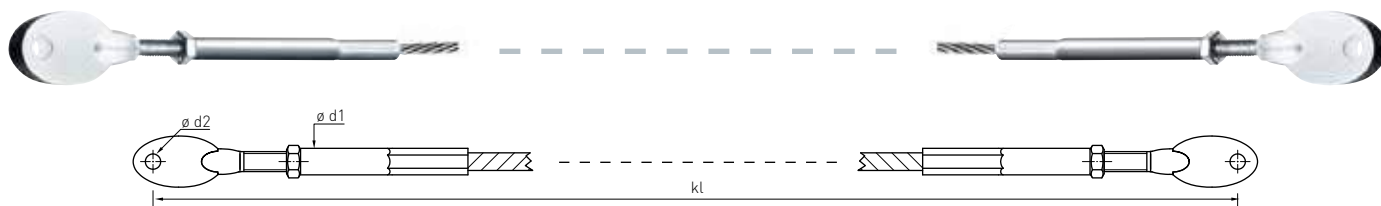

Artikelnummer Part number	\varnothing Seil \varnothing rope	Sk	Gewinde Thread	Spannweg Adjustment	$\varnothing d1$	$\varnothing d2$	kl min	kN
IK 405-0400	4	7 x 7	M6	+14 -22	8	6	352	8,9
IK 405-0500	5	7 x 7	M6	+14 -22	8	6	372	12
IK 405-0600	6	7 x 7	M8	+22 -42	10	8	434	16
IK 405-0800	8	7 x 7	M10	+22 -42	13	8	594	26

kN = Bruchkraft_kN = breaking load

EINE SEITE SPANNSCHLOSS MIT ÖSE, ANDERE SEITE ÖSE, VERPRESST_ONE SIDE TURNBUCKLE WITH EYE, OTHER SIDE WITH EYE, SWAGED

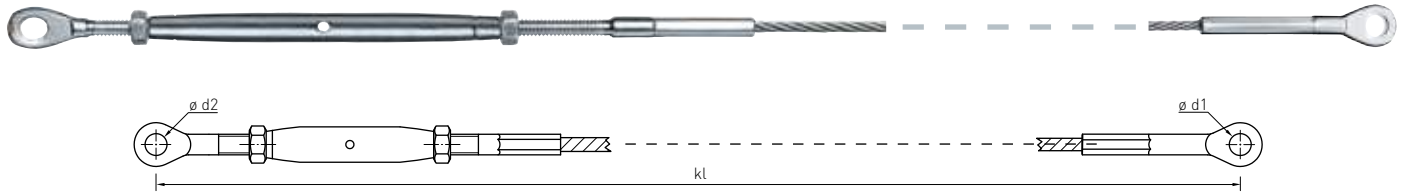

Artikelnummer Part number	∅ Seil ∅ rope	Sk	Gewinde Thread	Spannweg Adjustment	∅ d1	∅ d2	kl min	kN
IK 410-0200	2	7 x 7	M5	+26 -43	5,5	5,5	220	2,2
IK 410-0300	3	7 x 7	M6	+28 -50	6,5	6,5	240	5
IK 410-0400	4	7 x 7	M6	+28 -50	8,5	6,5	350	8,9
IK 410-0401	4	7 x 7	M8	+34 -50	8,5	8,5	380	8,9
IK 410-0500	5	7 x 7	M8	+34 -50	10,5	8,5	400	14
IK 410-0600	6	7 x 7	M10	+30 -50	13	10,5	460	20
IK 410-0800	8	7 x 7	M12	+46 -70	14,5	13	600	35
IK 410-1000	10	7 x 19	M16	+48 -90	16,3	14,5	715	52
IK 410-1200	12	7 x 19	M20	+60 -105	19,3	19,5	900	75

kN = Bruchkraft_kN = breaking load

BEIDE SEITEN SPANNSCHLOSS MIT ÖSE, VERPRESST_BOTH SIDES TURNBUCKLE WITH EYE, SWAGED

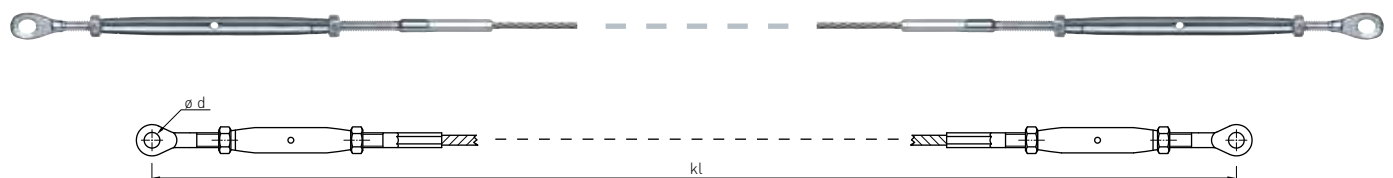

Artikelnummer Part number	∅ Seil ∅ rope	Sk	Gewinde Thread	Spannweg Adjustment	∅ d	kl min	kN
IK 420-0200	2	7 x 7	M5	+52 -86	5,5	345	2,2
IK 420-0300	3	7 x 7	M6	+56 -100	6,5	390	5
IK 420-0400	4	7 x 7	M6	+56 -100	6,5	500	8,9
IK 420-0401	4	7 x 7	M8	+68 -100	8,5	550	8,9
IK 420-0500	5	7 x 7	M8	+68 -100	8,5	560	14
IK 420-0600	6	7 x 7	M10	+60 -100	10,5	630	20
IK 420-0800	8	7 x 7	M12	+92 -140	13	820	35
IK 420-1000	10	7 x 19	M16	+96 -180	14,5	1100	52
IK 420-1200	12	7 x 19	M20	+120 -210	19,5	1300	75

kN = Bruchkraft_kN = breaking load

MONTAGEBEISPIELE

INSTALLATION EXAMPLES

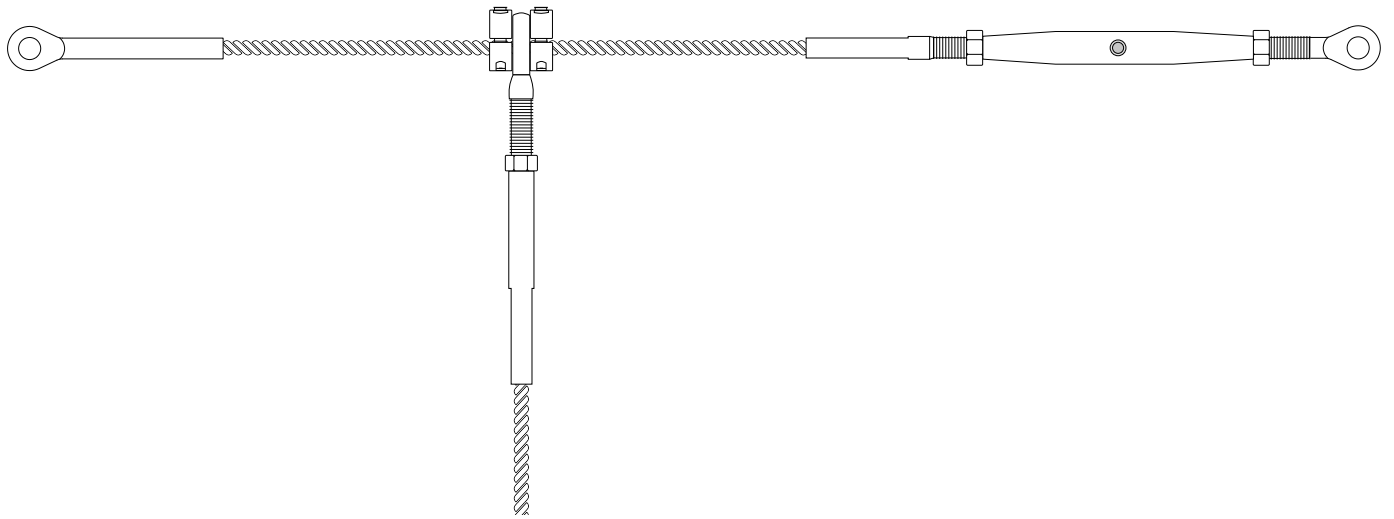

Beispiel 1_Example 1

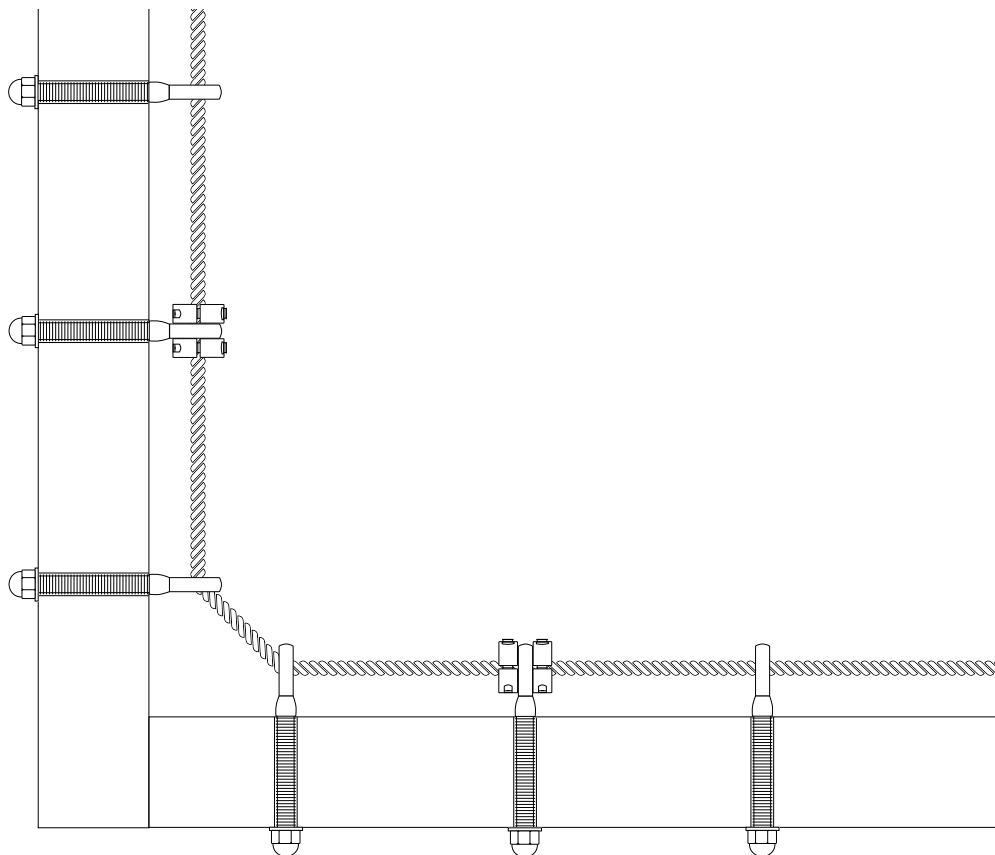

Beispiel 2_Example 2

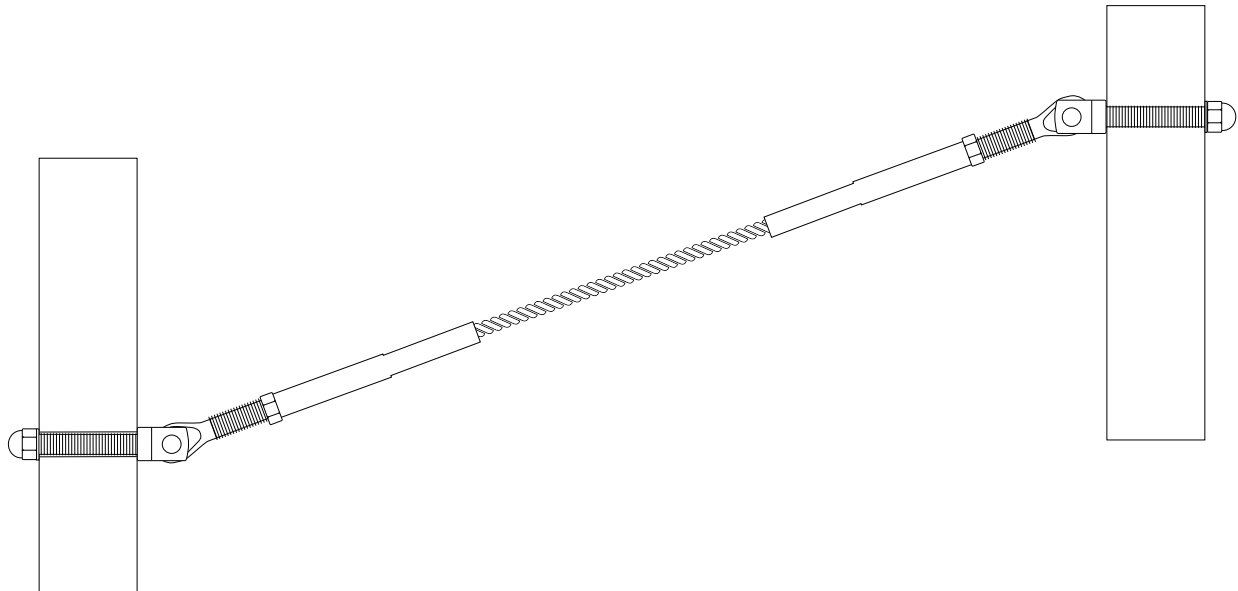

Beispiel 3_Example 3

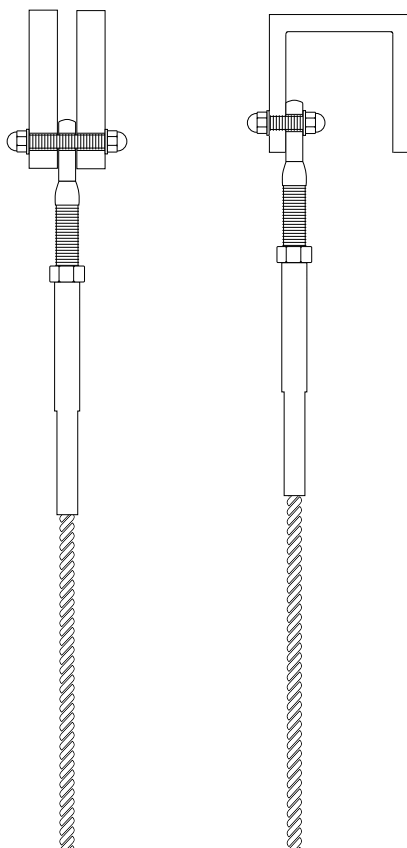

Beispiel 4_Example 4

<p>Beispiel 1 Example 1</p>	<p>An einem Trageil können Ösen aufgefädelt werden, die als Seilanschluss dienen. Mit leichten Klemmrings wird die Position fixiert.</p> <p>Eyes can be put onto a bearing cable to serve as cable connections. The position is fixed with light clamping rings.</p>
<p>Beispiel 2 Example 2</p>	<p>Ösen mit Außengewinde dienen der Seilführung, durch die Montage von leichten Klemmrings werden die Zugkräfte verteilt.</p> <p>Eyes with external thread serve to guide the cable, light clamping rings distribute the tensile forces.</p>
<p>Beispiel 3 Example 3</p>	<p>Konfektionen mit Öse können mit einem Ösengegenstück kombiniert werden.</p> <p>Assemblies with eye can be combined with eye counterpieces.</p>
<p>Beispiel 4 Example 4</p>	<p>Konfektionen mit Öse erlauben den Anschluss an Standardprofile.</p> <p>Assemblies with eyes allow connection to standard profiles.</p>

EINE RUNDE SACHE

WELL ROUNDED

Endhülsen sorgen für stabilen Halt. Ergänzt um Formteile gewährleisten sie eine sichere Verbindung für schräge Seilverläufe. Zu den herausragenden Produkten von I-SYS gehören Kugelkopf und Kugelpfanne. Das runde Duo ist eine zum Patent angemeldete technische Innovation für Endverbindungen in Steigungswinkeln bis 60°. Das Prinzip der Beweglichkeit einer Kugel aus der Pfanne entstammt der Natur: Die Kugel sitzt fix auf der runden und daher immer passenden Pfanne. Formal schlüssige und schnelle Lösungen, die flexibel in den Winkel passen, sind das Ergebnis.

End stops ensure secure fixing. Along with preformed parts they offer secure connections for sloping cable runs. Balls and sockets are also among the exceptional products offered in the I-SYS range. This rounded duo is a technical innovation for end connections at angles of slope of up to 60 degrees and is the subject of a current patent application. The principle of movement between ball and socket originates from nature: the ball sits firmly on the socket, which is round and therefore invariably fits. Rapid and formally consistent solutions which fit flexibly into the angle are the result

**Merkmale**
Attributes

- **Aufs Minimalste reduziert**
- **Flexible Gestaltungsmöglichkeiten**
- **Ideal für schräge Anbindungsformen**
- **Formschöne Gestaltungselemente**

- Reduced to the essentials
- Flexible design options
- Ideal for sloping cable runs
- Attractive design elements

KOMPONENTEN

COMPONENTS

KUGELKOPF MIT INNENGEWINDE_BALL HEAD WITH INTERNAL THREAD

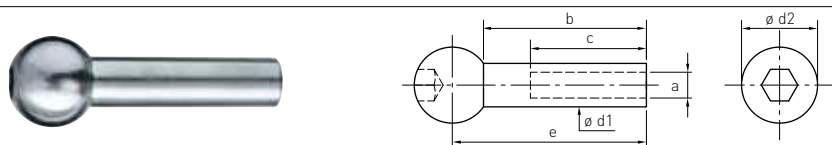

Artikelnummer Part number	a	c	b	e	$\varnothing d1$	$\varnothing d2$
868-0400	M4	15	25	31,3	6	14
868-0500	M5	20	30	36	7	14
868-0600	M6	20	30	35,7	8	14

Werkstoff 1.4401_Material AISI 316

FORMANSCHLUSS, VARIABEL, FÜR KUGELKOPF FÜR FLACHPROFIL_PIVOT BASE FOR BALL HEAD FOR FLAT PROFILE

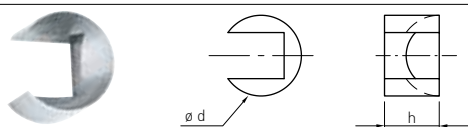

Artikelnummer Part number	h	$\varnothing d$
868-456	9,5	14

Werkstoff 1.4401_Material AISI 316

FORMANSCHLUSS, VARIABEL, FÜR KUGELKOPF FÜR RUNDPROFIL_PIVOT BASE FOR BALL HEAD FOR ROUND PROFILE

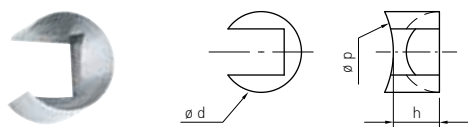

Artikelnummer Part number	h	$\varnothing d$	$\varnothing p$ Rohr $\varnothing p$ tube
868-034	9,5	14	34
868-043	9,5	14	42
868-060	9,5	14	60

Werkstoff 1.4401_Material AISI 316

LINSENKOPF MIT INNENGEWINDE_RADIUS HEAD END STOP WITH INTERNAL THREAD

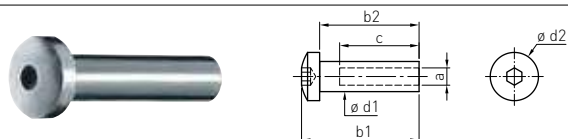

Artikelnummer Part number	a	b1	b2	c	$\varnothing d1$	$\varnothing d2$
869-0400-02	M4	29	25	15	6	10
869-0500-02	M5	34	30	20	7	12
869-0600-02	M6	35	30	20	8	14
869-0800-02	M8	40	34	25	10	16

Werkstoff 1.4404_Material AISI 316L

ALLE ANGABEN IN MILLIMETERN_ALL DIMENSIONS IN MILLIMETRES

ENDHÜLSE, VERPRESST_END STOP, SWAGED

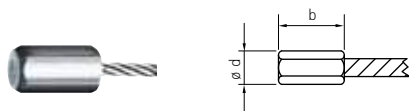

Artikelnummer Part number	b	ø d	ø Seil ø rope	kN
865-0200	12	8	2	2
865-0300	15	8	3	4,5
865-0400	20	13	4	8,1
865-0500	20	13	5	12,6
865-0600	30	18	6	18,1
865-0800	40	18	8	23,2

Werkstoff 1.4401 | kN = Bruchkraft_Material AISI 316 | kN = breaking load

ENDHÜLSE MIT LINSENKOPF, VERPRESST_ENDSTOP WITH RADIUS HEAD, SWAGED

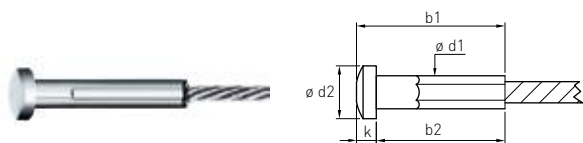

Artikelnummer Part number	b1	b2	ø d1	ø d2	ø Seil ø rope	kN
869-0200	24	21	5	8	2	2,9
869-0300	35	31	6	10	3	6,7
869-0400	40	36	7	12	4	11,9
869-0500	47	42	8	14	5	18,5
869-0600	58	52	10	16	6	26,7
869-0800	70	62	13	22	8	44,5

Werkstoff 1.4404 | kN = Bruchkraft_Material AISI 316L | kN = breaking load

LINSENKOPF, RUNDVERPRESST_ENDSTOP WITH RADIUS HEAD, ROUND SWAGED

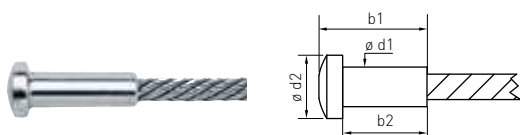

Artikelnummer Part number	b1	b2	ø d1	ø d2	ø Seil ø rope	kN
869-0200-04	9,08	6,2	3	6	2	1,6
869-0300-04	10,83	9	4,5	8	3	3,5
869-0400-04	14,09	12	5	10	4	6,3
869-0500-04	19,35	16	6	12	5	9,8
869-0600-04	24,14	18	8	16	6	14,1
869-0800-04	29,51	23,5	10,2	20	8	17

Werkstoff 1.4404 | kN = Bruchkraft_Material AISI 316L | kN = breaking load

SENKKOPF MIT INNENGEWINDE_COUNTERSUNK STOP WITH INTERNAL THREAD

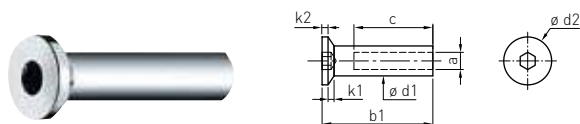

Artikelnummer Part number	a	b1	c	k1	k2	ø d1	ø d2
866-0400-02	M4	30,2	15	2,2	2	6	10,4
866-0500-02	M5	33,7	20	1,7	2	7	10,4
866-0600-02	M6	34,2	20	2,2	2	8	12,4
866-0800-02	M8	40,2	25	1,2	2	10	12,4

Werkstoff 1.4404_Material AISI 316L

SENKKOPF 90°, RUNDVERPRESST_END STOP COUNTERSUNK 90°, ROUND SWAGED

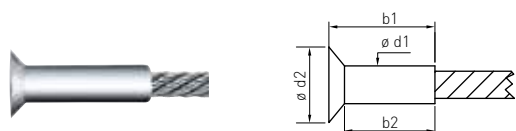

Artikelnummer Part number	b1	b2	ø d1	ø d2	ø Seil ø rope	kN
866-0200-04	8,7	6,2	3	6	2	1,6
866-0300-04	10	9	4,5	8	3	3,5
866-0400-04	13,5	12	5	10	4	6,3
866-0500-04	18,3	15	6	12	5	9,8
866-0600-04	22,4	18	8	16	6	14,1
866-0800-04	27,4	23,5	10,2	20	8	17

Werkstoff 1.4404 | kN = Bruchkraft_Material AISI 316L | kN = breaking load

ENDHÜLSE MIT SENKKOPF 90°, VERPRESST_ENDSTOP WITH COUNTERSUNK 90°, SWAGED

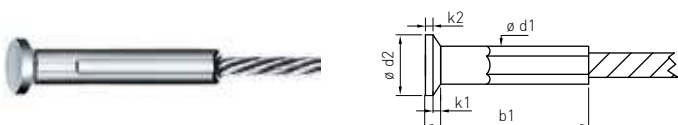

Artikelnummer Part number	b1	k1	k2	ø d1	ø d2	ø Seil ø rope	kN
866-0200	24,2	1,7	1,5	5	8,3	2	2,9
866-0300	35,2	2,2	2	6	10,4	3	6,7
866-0400	39,7	1,7	2	7	10,4	4	11,9
866-0500	46,2	2,2	2	8	12,4	5	18,9
866-0600	55,2	1,2	2	10	12,4	6	26,7
866-0800	68,8	3,8	3	13	20,5	8	44,5

Werkstoff 1.4404 | kN = Bruchkraft_Material AISI 316L | kN = breaking load

ALLE ANGABEN IN MILLIMETERN_ALL DIMENSIONS IN MILLIMETRES

LINSENKOPF MIT AUSSENGEWINDE, GEHÄMMERT_RADIUS HEAD WITH EXTERNAL THREAD, HAMMERED



Artikelnummer Part number	ø Seil ø rope	Gewinde Thread	ø d1 ^{+0,2} ₀	ø d2	kN
170-0400	4	M5	5	7	7,1
170-0500	5	M6	6	8	11
170-0600	6	M8	8	10	16

kN = Bruchkraft_kN = breaking load

SENKKOPF MIT AUSSENGEWINDE, GEHÄMMERT_COUNTERSUNK HEAD WITH EXTERNAL THREAD, HAMMERED

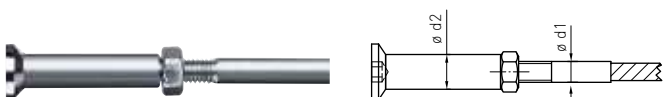

Artikelnummer Part number	ø Seil ø rope	Gewinde Thread	ø d1 ^{+0,2} ₀	ø d2	kN
180-0400	4	M5	5	7	7,1
180-0500	5	M6	6	8	11
180-0600	6	M8	8	10	16

kN = Bruchkraft_kN = breaking load

KUGELKOPF MIT AUSSENGEWINDE, GEHÄMMERT_BALL HEAD WITH EXTERNAL THREAD, HAMMERED



Artikelnummer Part number	ø Seil ø rope	Gewinde Thread	ø d1 ^{+0,2} ₀	ø d2	ø d3	kN
190-0300	3	M4	4	6	14	4,0
190-0400	4	M5	5	7	14	7,1
190-0500	5	M6	6	8	14	11

kN = Bruchkraft_kN = breaking load

KONFEKTIONEN: ENDHÜLSEN

ASSEMBLY DRAWINGS: END STOPS

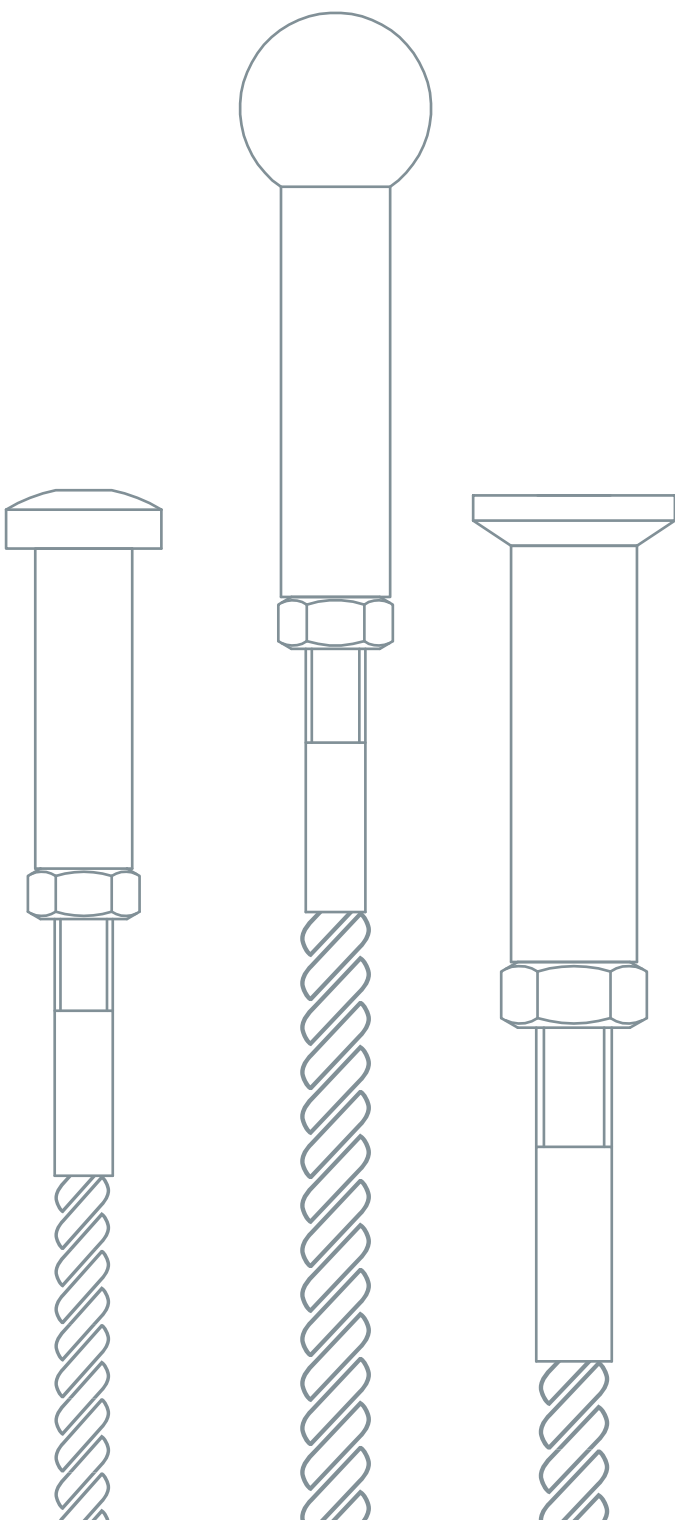

BEIDE SEITEN MIT AUSSENGEWINDE F30 UND AUFGEDREHTER LINSENKOPFHÜLSE
BOTH SIDES WITH EXTERNAL THREAD F30 AND SWAGELESS-ON RADIUS END STOP

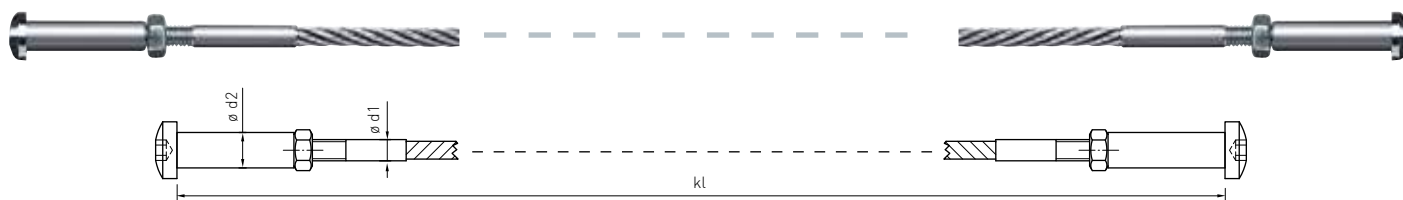

Artikelnummer Part number	\varnothing Seil \varnothing rope	Sk	Gewinde Thread	Spannweg Adjustment	$\varnothing d1^{+0,2}_0$	$\varnothing d2$	kl min	kN
IK 170-0400	4	7 x 7	M5	+6 -24	5	7	270	7,1
IK 170-0500	5	7 x 7	M6	+6 -22	6	8	280	11
IK 170-0600	6	7 x 7	M8	+8 -26	8	10	290	16

kN = Bruchkraft_kN = breaking load

BEIDE SEITEN MIT AUSSENGEWINDE F30 UND AUFGEDREHTER SENKKOPFHÜLSE
BOTH SIDES WITH EXTERNAL THREAD F30 AND SWAGELESS-ON COUNTERSUNK END STOP

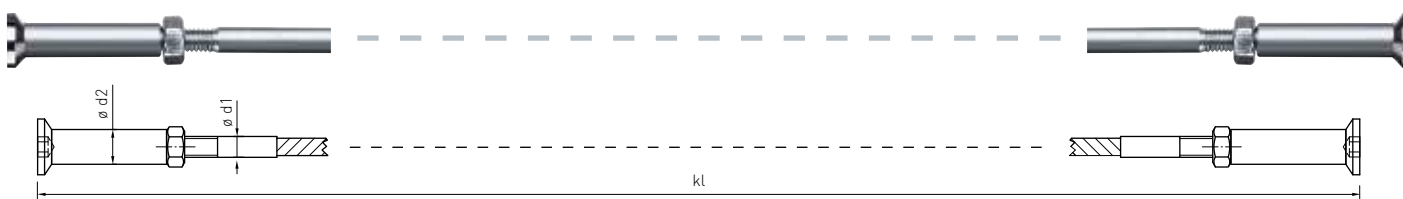

Artikelnummer Part number	\varnothing Seil \varnothing rope	Sk	Gewinde Thread	Spannweg Adjustment	$\varnothing d1^{+0,2}_0$	$\varnothing d2$	kl min	kN
IK 180-0400	4	7 x 7	M5	+6 -24	5	7	270	7,1
IK 180-0500	5	7 x 7	M6	+6 -22	6	8	280	11
IK 180-0600	6	7 x 7	M8	+8 -26	8	10	290	16

kN = Bruchkraft_kN = breaking load

BEIDE SEITEN MIT AUSSENGEWINDE F30 UND AUFGEDREHTEM KUGELKOPF
BOTH SIDES WITH EXTERNAL THREAD F30 AND SWAGELESS-ON BALL HEAD

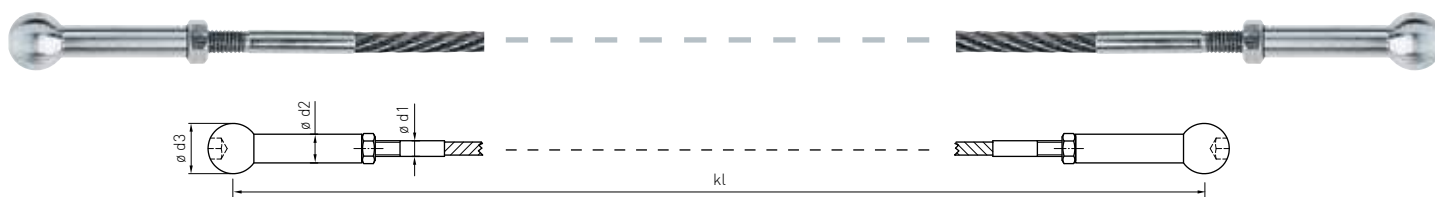

Artikelnummer Part number	\varnothing Seil \varnothing rope	Sk	Gewinde Thread	Spannweg Adjustment	$\varnothing d1^{+0,2}_0$	$\varnothing d2$	$\varnothing d3$	kl min	kN
IK 190-0300	3	7 x 7	M4	+4 -15	4	6	14	260	4,0
IK 190-0400	4	7 x 7	M5	+5 -20	5	7	14	270	7,1
IK 190-0500	5	7 x 7	M6	+5 -20	6	8	14	280	11

kN = Bruchkraft_kN = breaking load

EINE SEITE AUSSENGEWINDE, VERPRESST, ANDERE SEITE ENDHÜLSE MIT LINSKOPF, VERPRESST
ONE SIDE EXTERNAL THREAD SWAGED, OTHER SIDE RADIUS HEAD END STOP SWAGED

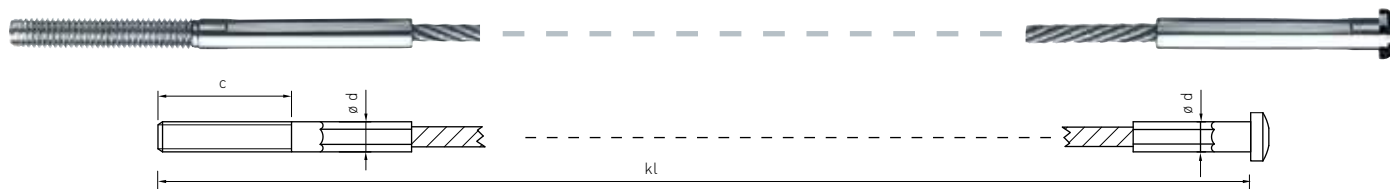

Artikelnummer Part number	$\varnothing\text{Seil}$ $\varnothing\text{ rope}$	Sk	Gewinde Größe x Länge c Thread size x length c	$\varnothing d$	kl min	kN
IK 150-0200	2	7 x 7	M5 x 30	5	120	2,2
IK 150-0201	2	7 x 7	M5 x 60	5	140	2,2
IK 150-0300	3	7 x 7	M6 x 30	6	140	5
IK 150-0301	3	7 x 7	M6 x 60	6	170	5
IK 150-0400	4	7 x 7	M6 x 30	7	150	8,9
IK 150-0401	4	7 x 7	M6 x 60	7	180	8,9
IK 150-0500	5	7 x 7	M8 x 30	8	170	14
IK 150-0501	5	7 x 7	M8 x 60	8	200	14
IK 150-0600	6	7 x 7	M10 x 30	10	190	20
IK 150-0601	6	7 x 7	M10 x 60	10	220	20
IK 150-0800	8	7 x 7	M12 x 80	13	300	35

kN = Bruchkraft_kN = breaking load

EINE SEITE AUSSENGEWINDE, VERPRESST, ANDERE SEITE ENDHÜLSE MIT SENKKOPF, VERPRESST
ONE SIDE EXTERNAL THREAD SWAGED, OTHER SIDE COUNTERSUNK HEAD END STOP SWAGED

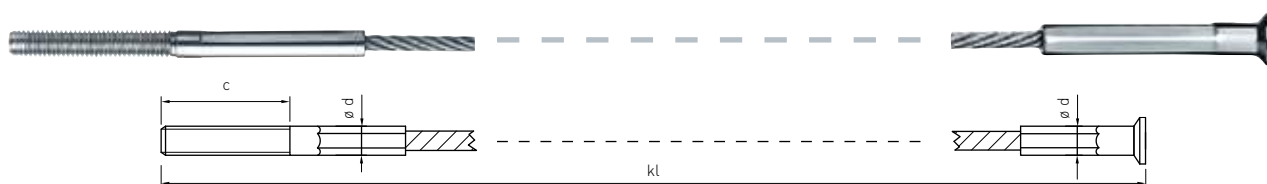

Artikelnummer Part number	$\varnothing\text{Seil}$ $\varnothing\text{ rope}$	Sk	Gewinde Größe x Länge c Thread size x length c	$\varnothing d$	kl min	kN
IK 160-0200	2	7 x 7	M5 x 30	5	120	2,2
IK 160-0201	2	7 x 7	M5 x 60	5	140	2,2
IK 160-0300	3	7 x 7	M6 x 30	6	140	5
IK 160-0301	3	7 x 7	M6 x 60	6	170	5
IK 160-0400	4	7 x 7	M6 x 30	7	150	8,9
IK 160-0401	4	7 x 7	M6 x 60	7	180	8,9
IK 160-0500	5	7 x 7	M8 x 30	8	170	14
IK 160-0501	5	7 x 7	M8 x 60	8	200	14
IK 160-0600	6	7 x 7	M10 x 30	10	190	20
IK 160-0601	6	7 x 7	M10 x 60	10	220	20
IK 160-0800	8	7 x 7	M12 x 80	13	300	35

kN = Bruchkraft_kN = breaking load

ALLE ANGABEN IN MILLIMETERN_ALL DIMENSIONS IN MILLIMETRES

MONTAGEBEISPIELE

INSTALLATION EXAMPLES

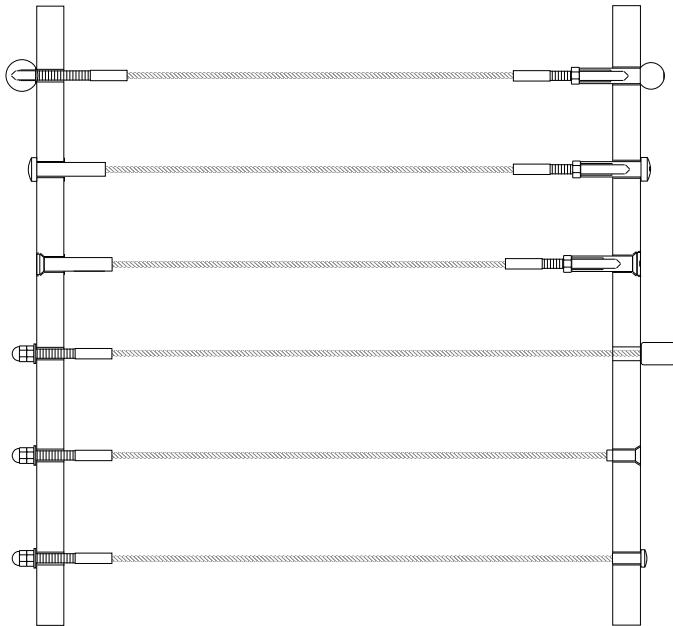

Beispiel 1_Example 1

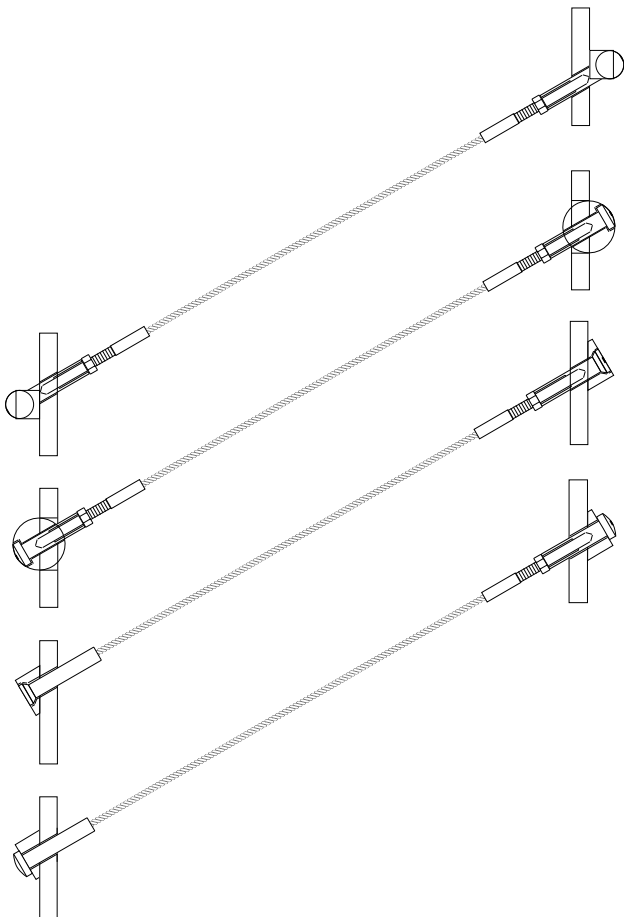

Beispiel 2_Example 2

<p>Beispiel 1 Example 1</p>	<p>Anschluss- und Kombinationsmöglichkeiten für Endhülsen bei rechtwinkliger Befestigung am Profil</p> <p>Possible connections and combinations for end stops in rectangular situations</p>
<p>Beispiel 2 Example 2</p>	<p>Anschluss- und Kombinationsmöglichkeiten für Endhülsen bei schräger Befestigung am Profil</p> <p>Possible connections and combinations for end stops in angled situations</p>

FORMSCHÖNE SEILSCHAFT

GLAMOROUS ROPES

Edelstahlseile gehören zu den vielseitigsten Elementen der Architektur. Funktional oder fein, statisch oder dekorativ, unauffällig integriert oder als Eye-Catcher gestaltet – Seile erweitern das Bauen um die schöpferische Dimension. Mit den Durchmessern von 1 bis 26 Millimetern und Endverbindungen von M4 bis M36 liefert I-SYS das passende Programm für individuelle Anwendungen. Die formale Einheit von Seil und Verbindung wird mit I-SYS zum vollkommenen Detail der Architektur.

Selbst montiert oder passgenau geliefert – CARL STAHL ARCHITEKTUR folgt individuellen Wünschen. Denn entscheidend ist das Ergebnis. Für alle Fragen der Planung, der Konfektionierung, der Herstellung und schließlich der Montage bietet das professionelle Team der I-SYS Berater nützliche Antworten.

Stainless steel cables are some of the most adaptable elements within architecture. Of static significance or decorative, fine or functional, discreetly integrated or designed to be eye-catching – cables really add to the creative possibilities of building. With diameters of between 1 and 26 millimeters and end connections from M4 to M36, I-SYS offers the right range for individual applications. With I-SYS, the formal unit of cable and connection becomes a perfect architectural detail. Ready-assembled or ready to assembly – CARL STAHL ARCHITEKTUR follows the individual wishes of its clients. For the end result is what matters. The professional team of I-SYS advisors will find suitable solutions for all questions of planning, pre-assembly, manufacture and final erection and assembly.



**Merkmale**
Attributes

- Vielfältige Gestaltungsmöglichkeiten
- Bewährte Standardelemente
- Optisch ansprechende Oberflächen
- Flexible Montagelösungen

- Multiple design options
- Proven standard elements
- Surfaces with a high visual impact
- Flexible installation solutions

KOMPONENTEN

COMPONENTS

SPIRALSEIL 1 x 19_STRAND 1 x 19



Artikelnummer Part number	Ø Seil Ø rope	kN	MQ mm ²
810-0200	2	3,30	2,39
810-0300	3	7,42	5,37
810-0400	4	13,20	9,55
810-0500	5	20,60	14,92
810-0600	6	29,70	21,49
810-0800	8	49,40	38,20
810-1000	10	77,20	59,69
810-1200	12	104	85,95
810-1400	14	131	116,99
810-1600	16	176	152,81
810-1900	19	233	215,48
810-2200	22	299	288,90
810-2600	26	416	403,51

Werkstoff 1.4401

Eigenschaften: starr, geringe Dehnung, hohe Mindestbruchkraft
Anwendung: konstruktiver Einsatz, z. B. Windverbände, Aussteifungen, Vordachabhängungen | kN = Bruchkraft, MQ = metallischer Querschnitt | E-Modul: $1,3 \times 10^5$ N/mm²

Material AISI 316

Characteristics: rigid, low stretch characteristics, high minimum breaking load

Use: structural applications, for example wind stiffening structures, general stiffening structures, suspension of canopies |

kN = breaking load, MQ = metallic cross section |

E-Module: 1.3×10^5 N/mm²

SPIRALSEIL 1 x 37 | 1 x 61*_STRAND 1 x 37 | 1 x 61*



Artikelnummer Part number	Ø Seil Ø rope	kN	MQ mm ²
610-1600	16	184,6	150,8
610-1800	18	227,5	190,8
610-2200*	22	322	285,1
610-2600*	26	445	398,2

Werkstoff 1.4401

Eigenschaften: starr, geringe Dehnung, hohe Mindestbruchkraft
Anwendung: konstruktiver Einsatz, z. B. Windverbände, Aussteifungen, Vordachabhängungen | kN = Bruchkraft, MQ = metallischer Querschnitt | E-Modul: $1,3 \times 10^5$ N/mm²

Material AISI 316

Characteristics: rigid, low stretch characteristics, high minimum breaking load

Use: structural applications, for example wind stiffening structures, general stiffening structures, suspension of canopies |

kN = breaking load, MQ = metallic cross section |

E-Module: 1.3×10^5 N/mm²

RUNDLITZENSEIL 7 x 7_ROPE 7 x 7



Artikelnummer Part number	Ø Seil Ø rope	kN	MQ mm ²
820-0100	1	0,56	0,43
820-0200	2	2,88	1,71
820-0300	3	5,5	3,85
820-0400 	4	8,94	6,85
820-0500	5	14	10,70
820-0600	6	20,10	15,42
820-0800	8	35,80	27,40

Werkstoff 1.4401

Eigenschaften: mittlere Flexibilität, umlenkbar, universell einsetzbar

Anwendung: architektonischer Einsatz, z. B. Geländerfüllungen,

Begrünungen, Regalabhängungen | kN = Bruchkraft,

MQ = metallischer Querschnitt | E-Modul: 1,0 x 10⁵ N/mm²

Material AISI 316

Characteristics: medium flexibility, can be angled and directionally reversed, for universal use

Use: use for architectural feature, for example stairway and walkway fillings, greenery, shelf hanging | kN = breaking load, MQ = metallic cross section | E-Module: 1.0 x 10⁵ N/mm²

RUNDLITZENSEIL 7 x 19_ROPE 7 x 19



Artikelnummer Part number	Ø Seil Ø rope	kN	MQ mm ²
830-0200	2	2,56	1,66
830-0300	3	4,69	3,73
830-0400 	4	8,34	6,63
830-0500	5	13	10,36
830-0600	6	18,8	14,92
830-0800	8	33,4	26,53
830-1000	10	52,1	41,45
830-1200	12	75,1	59,69
830-1400	14	102	81,25
830-1600	16	133	106,12

Werkstoff 1.4401

Eigenschaften: hohe Flexibilität, umlenkbar, universell einsetzbar

Anwendung: architektonischer Einsatz, z. B. Geländerfüllungen,

Begrünungen, Regalabhängungen | kN = Bruchkraft,

MQ = metallischer Querschnitt | E-Modul: 1,0 x 10⁵ N/mm²

Material AISI 316

Characteristics: high flexibility, can be angled and directionally reversed, for universal use

Use: use for architectural feature, for example stairway and walkway fillings, greenery, shelf hanging | kN = breaking load, MQ = Metallic cross section | E-Module: 1.0 x 10⁵ N/mm²

STAB MIT BEIDSEITIGEM GEWINDE, RECHTS- ODER LINKSGÄNGIG_ROD WITH BOTH SIDE THREAD, RIGHT OR LEFT HAND

Artikelnummer Part number	Ø Stab Ø rod	Gewindegröße x Länge Thread size x length	kN*
IS-625	6	M6 x 25	3,88
IS-830	8	M8 x 30	7,08
IS-1040	10	M10 x 40	11,22
IS-1250	12	M12 x 50	16,31
IS-1660	16	M16 x 60	30,38

Werkstoff 1.4571 | Stablänge max. 2 m | *Zulässige Zugbelastung

Material AISI 316Ti | Rod length maximum 2 m | *permissible load

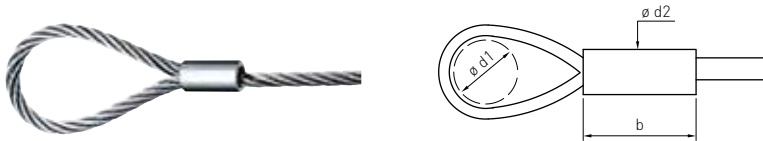
SCHLAUFEN, VERPRESST, OHNE KAUSCHE_LOOP SWAGED WITHOUT THIMBLE

Artikelnummer Part number	b	Ø d1	Ø d2	Ø Seil Ø rope	kN
803-0200	10	x*	4	2	2
803-0300	13	x*	6	3	4,5
803-0400	16	x*	8	4	8,1
803-0500	20	x*	10	5	12,6
803-0600	28	x*	13	6	18,1
803-0800	40	x*	16	8	32,2
803-1000	50	x*	20	10	46,9
803-1200	60	x*	24	12	67,6
803-1400	70	x*	28	14	91,8
803-1600	80	x*	32	16	119,7

Presshülse | Werkstoff 1.4404 | *Maß Ø d1 variabel. Nicht geeignet für Spiralseile | kN = Bruchkraft

Ferrule | Material 1.4404 | *Dimension Ø d1 variable. Not suitable for strands | kN = breaking load

SCHLAUFEN, VERPRESST, MIT KAUSCHE_LOOP SWAGED WITH THIMBLE

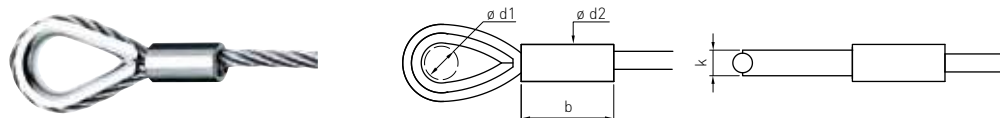

Artikelnummer Part number	b	k	ø d1	ø d2	ø Seil ø rope	kN
804-0200	10	4	6,5	7	2	2
804-0300	13	5,5	9,5	9	3	4,5
804-0400	16	6,5	10,5	13	4	8,1
804-0500	20	8	12,5	15	5	12,6
804-0600	28	9	15,5	13	6	18,1
804-0800	40	12	17,5	16	8	32,2
804-1000	50	14	23,5	20	10	46,9
804-1200	60	20	25,5	24	12	67,6
804-1400	70	22	33,5	28	14	91,8
804-1600	80	24	36,5	32	16	119,7

Presshülse | Werkstoff 1.4404 | Nicht geeignet für Spiralseile | kN = Bruchkraft

Ferrule | Material 1.4404 | Not suitable for strands | kN = breaking load

BÜGELKLEMME, SCHWERE AUSFÜHRUNG_WIRE ROPE GRIP, HEAVY TYP

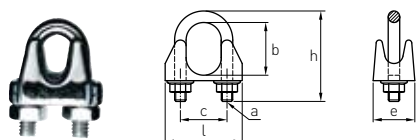

Artikelnummer Part number	ø Seil ø rope	Klemme pro Schlaufe Grips per Loop	a	b (min./max.)	c	l	h	e
800-0200	2	3	M3	3/9	8	14	18	13
800-0300	3	3	M4	5/12	8	17	24	15
800-0400	4	3	M4	5/12	10	19	24	17
800-0500	5	4	M5	5/17	13	24	33	19
800-0600	6	4	M6	4/15	14	28	33	20
800-0800	8	4	M8	5/16	19	34	40	27
800-1000	10	4	M10	8/23	21	45	50	29
800-1200	12	4	M12	8/29	26	51	60	32
800-1400	14	4	M12	7/33	28	53	65	39
800-1600	16	4	M14	10/40	33	60	75	42

Werkstoff 1.4401 | Nicht geeignet für Spiralseile_Material AISI 316 | Not suitable for strands

KAUSCHE_THIMBLE

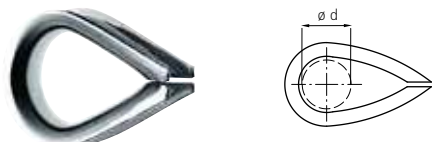

Artikelnummer Part number	ø d	ø Seil ø rope
5970.00.02	6,5	2
5970.00.03	9,5	3
5970.00.04	10,5	4
5970.00.05	12,5	5
5970.00.06	15,5	6
5970.00.08	17,5	8
5970.00.10	23,5	10
5970.00.12	25,5	12
5970.00.14	33,5	14
5970.00.16	36,5	16

Werkstoff 1.4401_Material AISI 316

SCHLAUFENVERSCHRAUBUNG, ZWEITEILIG, MIT KAUSCHE_LOOP CLAMP RING WITH THIMBLE

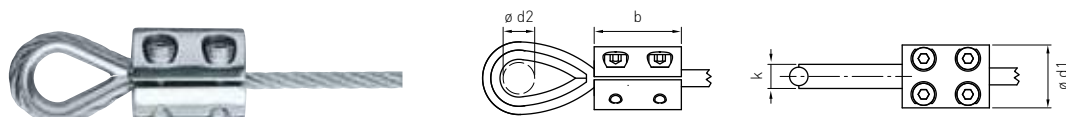

Artikelnummer Part number	b	k	ø d1	ø d2	ø Seil ø rope	kN
874-0300	27	5,5	22	9,5	3	4,9
874-0400	27	6,5	22	10,5	4	5,1
874-0500	42	8	28	12,5	5	7,8
874-0600	42	9	28	15,5	6	12
874-0800	42	12	28	17,5	8	13

Werkstoff 1.4401 | Nicht geeignet für Spiralseile | kN = Bruchkraft_Material AISI 316 | Not suitable for strands | kN = breaking load

LEICHTE SCHLAUFENVERSCHRAUBUNG, ZWEITEILIG, MIT KAUSCHE_LIGHT CLAMP RING WITH THIMBLE

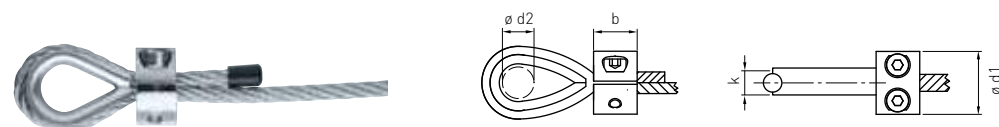

Artikelnummer Part number	b	k	ø d1	ø d2	ø Seil ø rope	kN
874-0200-01	10	4	15	6,5	2	1,1
874-0300-01	10	5,5	15	9,5	3	2,4
874-0400-01	10	6,5	20	10,5	4	4

Werkstoff 1.4401 | Nicht geeignet für Spiralseile | kN = Bruchkraft_Material AISI 316 | Not suitable for strands | kN = breaking load

ALLE ANGABEN IN MILLIMETERN_ALL DIMENSIONS IN MILLIMETRES

SEILKLEMMKEGEL, VERSCHRAUBT_ROPE CLAMP CONE



Artikelnummer Part number	b	ø d	ø Seil ø rope	F ax
859-0300-03	90	30	3	1,3
859-0400-03	90	30	4	1,5

Werkstoff 1.4401 | Nicht geeignet für Spiralseile_Material AISI 316 | Not suitable for strands

ABDECKSCHEIBE FÜR SEILKLEMMKEGEL_COVER DISK FOR ROPE CLAMP CONE

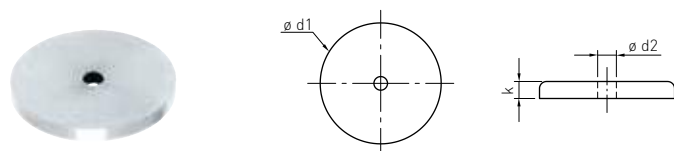

Artikelnummer Part number	k	ø d1	ø d2
859-03-04	4	30	4,5

Werkstoff 1.4571_Material AISI 316Ti

CS-SEILKREUZ, VERSTELLBAR_CS-CROSS CLAMP, ADJUSTABLE

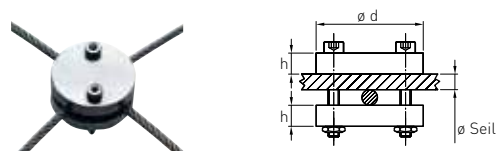

Artikelnummer Part number	h	ø d	ø Seil ø rope
858-36	6	36	4-6
858-42	8	42	8-12

Werkstoff 1.4401_Material AISI 316

SEILKREUZ MIT KLEMMHALTERUNG_CROSS CLAMP WITH CONNECTION

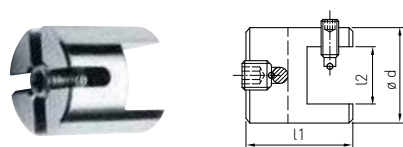

Artikelnummer Part number	l1	l2	ø d	ø Seil ø rope
858-0400-04	28	15	25	3-4
858-0600-04	32	15	25	5-6

Werkstoff 1.4401_Material AISI 316

SEILKREUZ, VERSTELLBAR_CROSS CLAMP, ADJUSTABLE

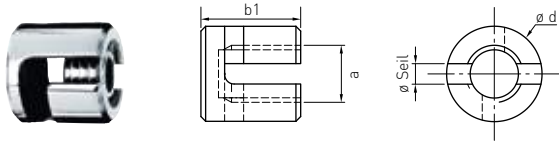

Artikelnummer Part number	a	b1	ø d	ø Seil ø rope
858-0400-01	M12	19,5	20	3-4
858-0600-01	M12	23,5	20	5-6

Werkstoff 1.4401_Material AISI 316

SEILKREUZ, VERSTELLBAR, MIT INNENGEWINDE_CROSS CLAMP WITH INTERNAL THREAD, ADJUSTABLE

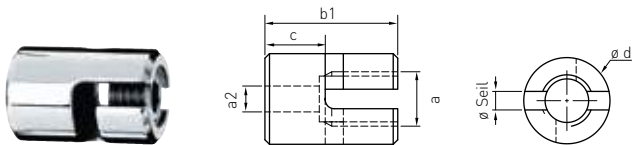

Artikelnummer Part number	a	a2	b1	c	ø d	ø Seil ø rope
858-0400-02	M12	M8	31	15	20	3-4
858-0600-02	M12	M8	35	15	20	5-6

Werkstoff 1.4401_Material AISI 316

SEILKREUZ 90°_CROSS CLAMP 90°

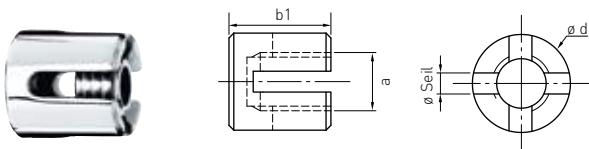

Artikelnummer Part number	a	b1	ø d	ø Seil ø rope
858-0400	M12	21	20	3-4
858-0600	M12	25	20	5-6

Werkstoff 1.4401_Material AISI 316

KLEMMRING, ZWEITEILIG_TWO PART CLAMP RING

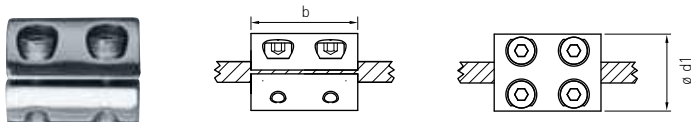

Artikelnummer Part number	b	ø d1	ø Seil ø rope	F ax [kN]
873-0300	27	22	3	3
873-0400	27	22	4	3,6
873-0500	42	28	5	5,8
873-0600	42	28	6	6,5
873-0800	42	28	8	9,4

Werkstoff 1.4401 | Nicht geeignet für Spiralseile_Material AISI 316 | Not suitable for strands

LEICHTER KLEMMRING MIT AUFLAGE_LIGHT CLAMP RING WITH ADAPTER

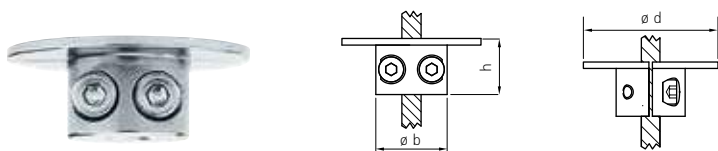

Artikelnummer Part number	ø b	h	ø d	ø Seil ø rope	F ax [kN]
863-0200-02	15	11,5	30	2	1
863-0300-02	15	11,5	30	3	1,3
863-0400-02	15	11,5	30	4	1,5
863-0500-02	20	11,5	35	5	2
863-0600-02	20	11,5	35	6	2,2
863-0800-02	20	11,5	35	8	2,2

Werkstoff 1.4401 | Nicht geeignet für Spiralseile_Material AISI 316 | Not suitable for strands

LEICHTER KLEMMRING, ZWEITEILIG_LIGHT CLAMP RING

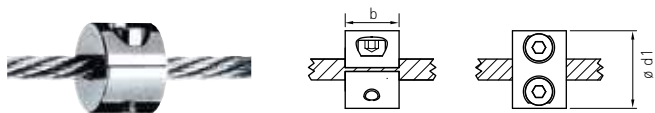

Artikelnummer Part number	b	ø d1	ø Seil ø rope	F ax [kN]
863-0200	10	15	2	1
863-0300	10	15	3	1,3
863-0400	10	15	4	1,5
863-0500	10	24	5	2
863-0600	10	24	6	2,2
863-0800	10	24	8	2,2
863-1000	15	32	10	2,5

Werkstoff 1.4401 | Nicht geeignet für Spiralseile_Material AISI 316 | Not suitable for strands

SEILFÜHRUNG GABELKOPF_ROPE GUIDING, FORK HEAD

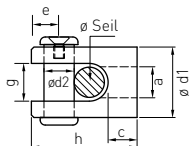

Artikelnummer Part number	a	c	e	g	h	ø d1	ø d2	ø Seil ø rope
921-1000-28	M12	13	18	12	48	28	11±0,2	8/10
921-1200-28	M12	13	18	13,5	50	28	11±0,2	12

Werkstoff 1.4401_Material AISI 316

SEILUMLENKUNG_ROPE PULLEY BLOCK

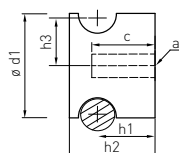

Artikelnummer Part number	a	c	h1	h2	h3	ø d1	ø Seil ø rope
921-0600-30	M10	16	17	25	14,5	30	6
921-0800-30	M10	16	17	26	13,5	30	8

Werkstoff 1.4401_Material AISI 316

FORMANSCHLUSS_ANGLE STAND OFF WASHER

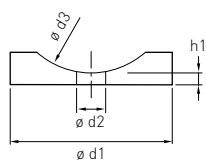

Artikelnummer Part number	ø d1	ø d2	ø d3	h1
862-921-20	16	10,5	20	3
862-921-28	22	10,5	28	3
862-921-34	40	10,2	34	3
862-921-48	40	10,2	48	3

Werkstoff 1.4401_Material AISI 316

SEILFÜHRUNG ZYLINDRISCH_ROD/ROPE HOLDER

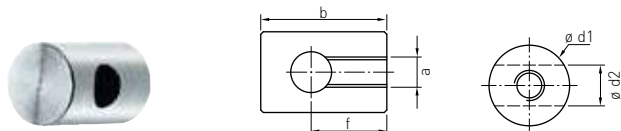

Artikelnummer Part number	a	b	f	ø d1	ø d2
921-0600-12	M6	25	15	16	8,1
921-0800-12	M10	25	17	18	11
921-1000-02	M8	31	18	20	10,5
921-1000-12	M12	35	19	28	11,5
921-1200-12	M12	35	19	28	15
921-1200-13 mit Radiuskante_with radius edge	M12	35	19	28	15

Werkstoff 1.4401_Material AISI 316

ANSCHRAUBKLEMME, ZWEITEILIG_SCREW ON CROSS CLAMP

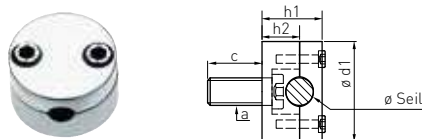

Artikelnummer Part number	a	c	h1	h2	ø d1	ø Seil ø rope
858-0600-06	M8	16	25	15	40	6
858-0800-06	M8	16	25	15	40	8
858-1000-06	M8	16	25	15	40	10
858-1200-06	M8	16	25	15	40	12
858-1600-06	M10	16	32	19,5	48	16

Werkstoff 1.4401 | Nicht geeignet für Spiralseile_Material AISI 316 | Not suitable for strands

Anschlussschraube gemäß DIN 6912 mit flachem Kopf_Connecting screw according DIN 6912 with flat head

ANSCHRAUBKLEMME, VERSTELLBAR_ADJUSTABLE SCREW ON CROSS CLAMP

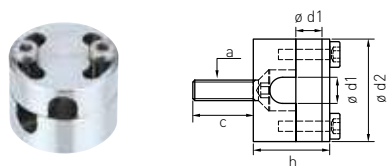

Artikelnummer Part number	a	c	h	ø d1	ø d2
858-0800-07	M8	19	27	8,5	40
858-1000-07	M8	19	30	10,2	40

Werkstoff 1.4401_Material AISI 316

Anschlussschraube gemäß DIN 7991 mit Senkkopf_Connecting screw according DIN 7991 with countersunk head

MONTAGEBEISPIELE

INSTALLATION EXAMPLES

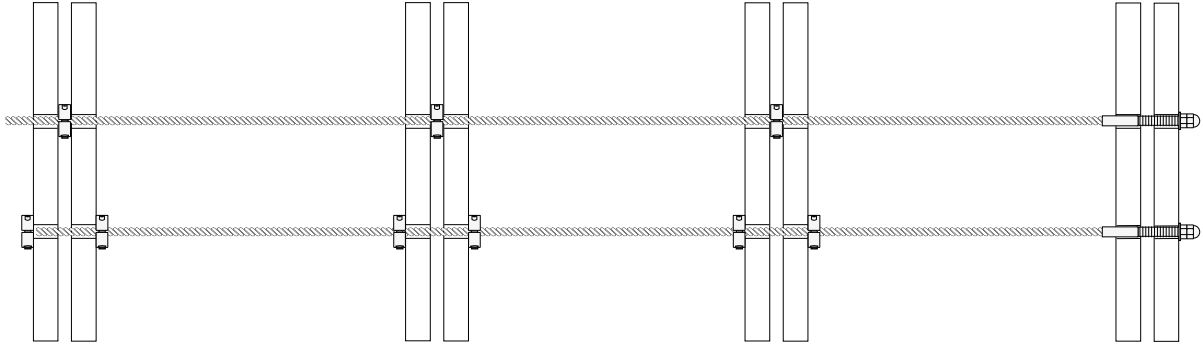

Beispiel 1_Example 1

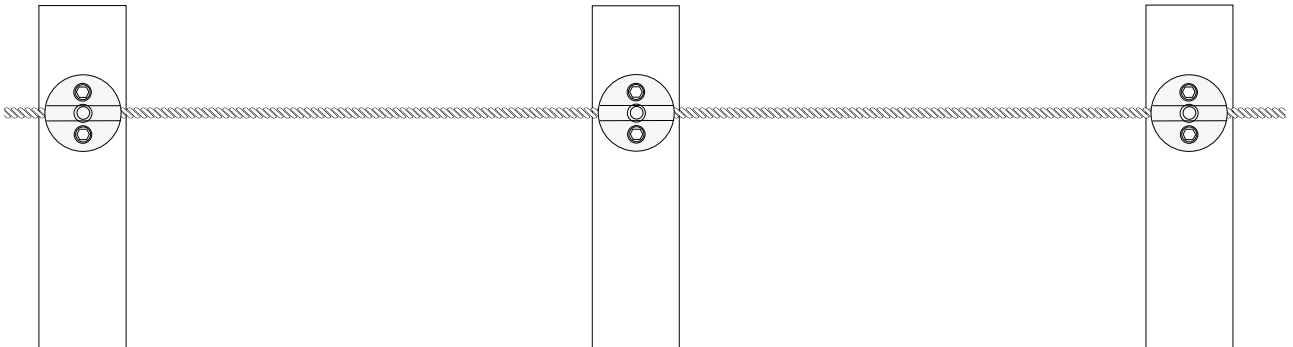

Beispiel 2_Example 2

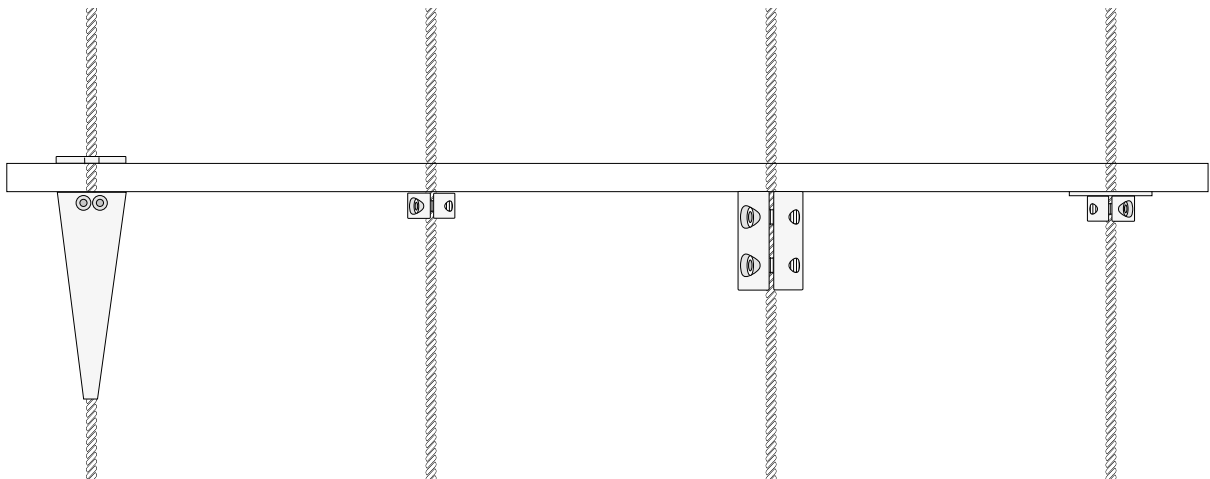

Beispiel 3_Example 3

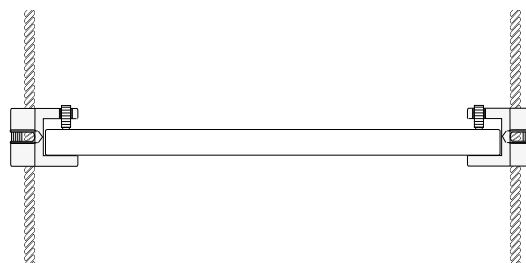
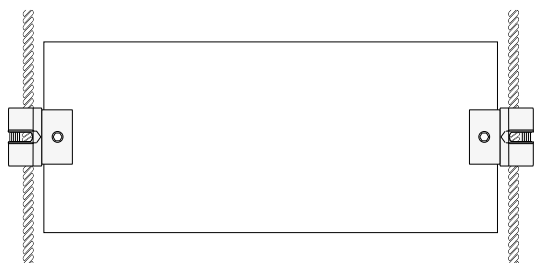

Beispiel 4_Example 4

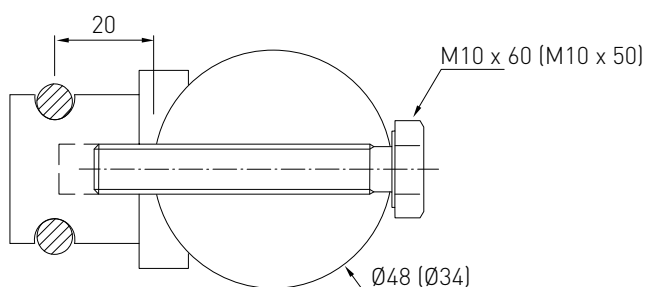

Beispiel 5_Example 5

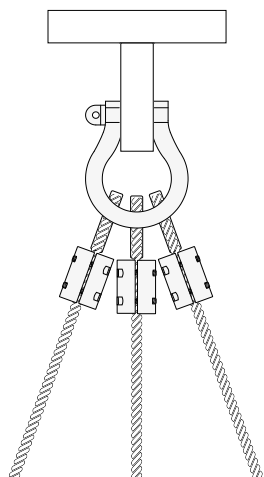

Beispiel 6_Example 6

Beispiel 1 Example 1	Leichte Klemmrings zur Verteilung der auftretenden Zugkräfte auf mehrere Profile Light clamp rings for distribution of tensile forces over several profiles
Beispiel 2 Example 2	Zweiteilige Anschraubklemme zur Seilführung und -klemmung Two-part screw clamp for cable guide and clamping
Beispiel 3 Example 3	Seilklemmkegel mit Abdeckscheibe, leichter Klemmring, Klemmring, leichter Klemmring mit Auflage zur horizontalen Abhängung von Regalböden und Tablar Cable cone clamp with cover disc, light clamp ring, clamp ring, light clamp ring with support for horizontal hanging of shelves and tablets
Beispiel 4 Example 4	Seilkreuz mit Klemmhalterung zur horizontalen und vertikalen Abhängung von Displays und Regalböden Double cable junction with clamping holder for horizontal and vertical hanging of displays and shelves
Beispiel 5 Example 5	Seilumlenkung mit Formschluss für runde Profile Ø48 und Ø34 Rope pulley block with angle stand off washer or round posts Ø48 and Ø34
Beispiel 6 Example 6	Schlaufenverschraubungen in Schäkel, geschweißt Loop clamps attached to bow shackle

ROBUSTES RÜSTZEUG

RUGGED ACCESSORIES

Das Sortiment an Zubehör und Hilfsmitteln für das I-SYS System ist breit gefächert. Es umfasst umfangreiches Befestigungszubehör, das die Montage in Holz, Beton, Naturstein und Stahl ermöglicht. Spezialwerkzeuge für eine fachgerechte Montage runden das Programm ab.

A wide range of accessories and auxiliary materials can be supplied for the I-SYS system. They include numerous attachment accessories to simplify installation in wood, concrete, natural stone and steel material. Special tools for professional installation round off the assortment.



ZUBEHÖR

ACCESSORIES

FORMANSCHLUSS FÜR AUSSENGEWINDE, FLACHE PROFILE_ANGLE STAND OFF WASHER FOR EXTERNAL THREAD, FLAT PROFILE

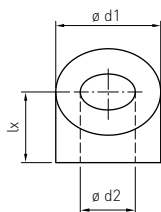

Artikelnummer Part number	Gewinde Thread	$\varnothing d1$	$\varnothing d2$
862-04-0	M4	10	4,3
862-05-0	M5	10	5,5
862-06-0	M6	13	7,3
862-08-0	M8	18	8,3
862-10-0	M10	22	10,5
862-12-0	M12	24	12,5
862-16-0	M16	32	17

Werkstoff 1.4401 | Für Bestellung bitte Steigungswinkel α angeben
Material AISI 316 | Please specify the required angle when ordering.

FORMANSCHLUSS FÜR AUSSENGEWINDE, RUNDE PROFILE_ANGLE STAND OFF WASHER FOR EXTERNAL THREAD, ROUND PROFILE

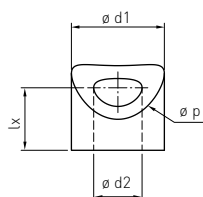

Artikelnummer Part number	Gewinde Thread	$\varnothing d1$	$\varnothing d2$
862-04-1	M4	10	4,3
862-05-1	M5	10	5,5
862-06-1	M6	13	7,3
862-08-1	M8	18	8,3
862-10-1	M10	22	10,5
862-12-1	M12	24	12,5
862-16-1	M16	32	17

Werkstoff 1.4401 | Für Bestellung bitte Pfostendurchmesser $\varnothing p$ und Steigungswinkel α angeben_Material AISI 316 | Please specify diameter of post $\varnothing p$ and required angle α° when ordering.

FORMANSCHLUSS FÜR ENDHÜLSE MIT SENKKOPF 90°, FLACHE PROFILE ANGLE WASHER FOR COUNTERSUNK END STOP 90°, FLAT PROFILE

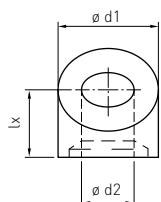

Artikelnummer Part number	$\varnothing d1$	$\varnothing d2$
862-03-2	13	7,3
862-04-2	13	8,3
862-05-2	18	8,3
862-06-2	18	10,5
862-08-2	24	13,5

Werkstoff 1.4401 | Für Bestellung bitte Steigungswinkel α angeben
Material AISI 316 | Please specify the required angle when ordering.

FORMANSCHLUSS FÜR ENDHÜLSE MIT SENKKOPF 90°, RUNDE PROFILE

ANGLE WASHER FOR COUNTERSUNK END STOP 90°, ROUND PROFILE

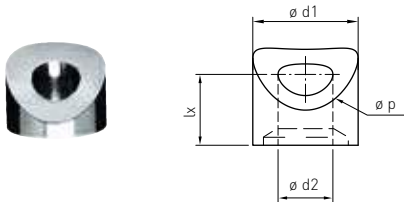

Artikelnummer Part number	$\varnothing d1$	$\varnothing d2$
862-03-3	13	7,3
862-04-3	13	8,3
862-05-3	18	8,3
862-06-3	18	10,5
862-08-3	24	13,5

Werkstoff 1.4401 | Für Bestellung bitte Pfostendurchmesser $\varnothing p$ und Steigungswinkel α angeben. Material AISI 316 | Please specify diameter of post $\varnothing p$ and required angle α° when ordering.

LÄNGE lx VON FORMANSCHLÜSSEN_LENGTH lx FOR ANGLE STAND OFF WASHERS

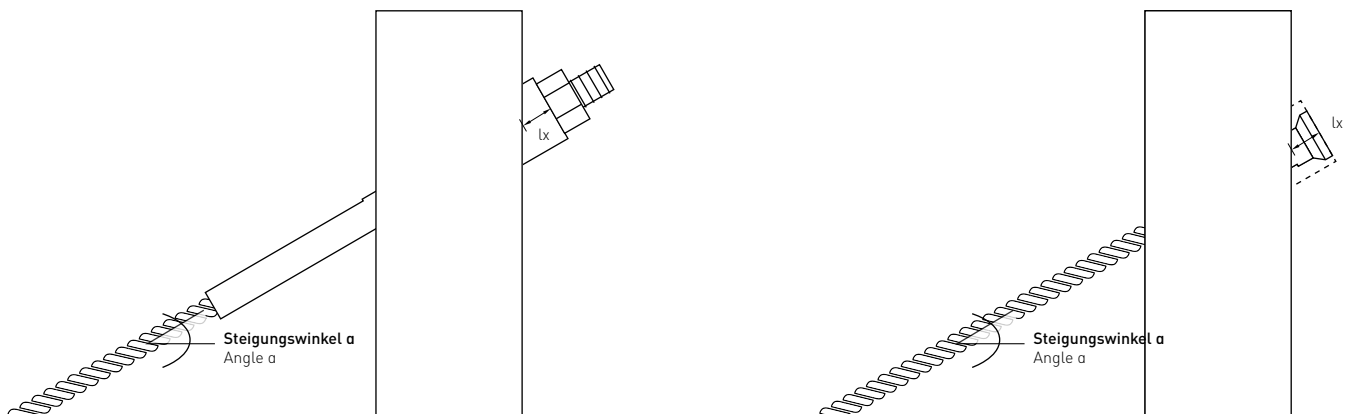

$\varnothing d1$	$\alpha 0^\circ$	$\alpha 5^\circ$	$\alpha 10^\circ$	$\alpha 15^\circ$	$\alpha 20^\circ$	$\alpha 25^\circ$	$\alpha 30^\circ$	$\alpha 32^\circ$	$\alpha 35^\circ$	$\alpha 37^\circ$	$\alpha 40^\circ$	$\alpha 45^\circ$	$\alpha 50^\circ$	$\alpha 55^\circ$	$\alpha 60^\circ$
8	3,0	3,4	3,7	4,1	4,5	4,9	5,3	5,5	5,8	6,0	6,4	7,0	7,8	8,7	9,0
10	3,0	3,4	3,9	4,3	4,8	5,3	5,9	6,1	6,5	6,8	7,2	8,0	9,0	10,1	11,7
13	3,0	4,6	4,6	5,0	5,5	6,0	7,0	7,1	7,6	7,9	8,5	9,5	10,7	12,3	14,3
18	3,0	4,0	4,6	5,4	6,3	7,2	8,2	8,6	9,3	9,8	10,6	12,0	13,7	15,9	18,6
22	3,0	4,0	4,9	5,9	7,0	8,1	9,4	9,9	10,7	11,3	12,2	14,0	16,1	18,7	22,0
24	7,0	8,0	9,0	10,0	11,0	12,5	14,0	14,5	15,5	16,0	17,0	19,0	21,0	24,0	28,0
32	7,0	8,5	10,0	11,0	12,8	14,5	16,2	17,0	18,2	19,1	20,4	23,0	26,1	30,0	34,7

SEILHÜLSE, VERSCHIEBBAR_LOOSE SLEEVE

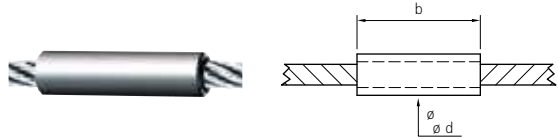

Artikelnummer Part number	b	ø d	ø Seil ø rope
864-0205	30	5	2
864-0306	30	6	3
864-0307	30	7	3
864-0310	30	10	3
864-0407	30	7	4
864-0407 M	40	7	4
864-0407 L	55	7	4
864-0408	30	8	4
864-0408 M	40	8	4
864-0408 L	55	8	4
864-0410	30	10	4
864-0508	30	8	5
864-0508 M	40	8	5
864-0508 L	55	8	5
864-0513	30	13	5
864-0610	30	10	6
864-0610 M	40	10	6
864-0610 L	55	10	6
864-0613	30	13	6
864-0813	30	13	8
864-1018	50	18	10
864-1020	50	20	10

Werkstoff 1.4401 | Die Hülse ist unverpresst auf das Seil geschoben und wird im Pfostenprofil verklebt

Material AISI 316 | The sleeve can slide along the length of the cable. Secure the sleeve to the post profile not the rope.

GEWINDEMUFFE_THREAD SLEEVE

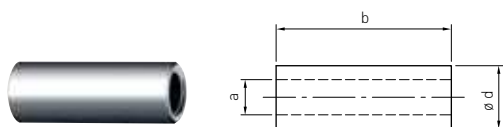

Artikelnummer Part number	a	b	ø d
876-0625	M6	25	10
876-0830	M8	30	11
876-1030	M10	30	13
876-1230	M12	30	15
876-1640	M16	40	25

Werkstoff 1.4401_Material AISI 316

KUGEL FÜR LINSENKOPF MIT INNENGEWINDE_BALL FOR INTERNAL THREAD RADIUS HEAD

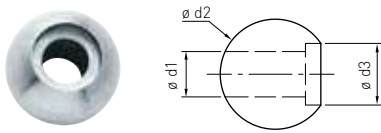

Artikelnummer Part number	$\varnothing d1$	$\varnothing d2$	$\varnothing d3$
899-06	6,5	20	10
899-07	7,5	20	12
899-08	9	25	14
899-10	11	25	16

Werkstoff 1.4401_Material AISI 316

KUGEL MIT INNENGEWINDE_BALL END WITH INTERNAL THREAD

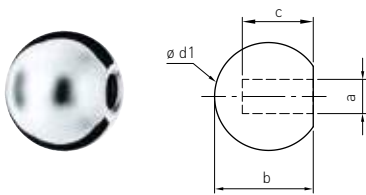

Artikelnummer Rechtsgewinde Part number RH thread	Artikelnummer Linksgewinde Part number LH thread	a	b	c	$\varnothing d1$
898-0400-01	898-0400-02	M4	15	9	16
898-0500-01	898-0500-02	M5	15	9	16
898-0600-01	898-0600-02	M6	18,8	10	20
898-0800-01	898-0800-02	M8	22,4	12	24
898-1000-01	898-1000-02	M10	21,4	12	24

Werkstoff 1.4401_Material AISI 316

SCHÄKEL, GERADE FORM_SHACKLE D-FORM

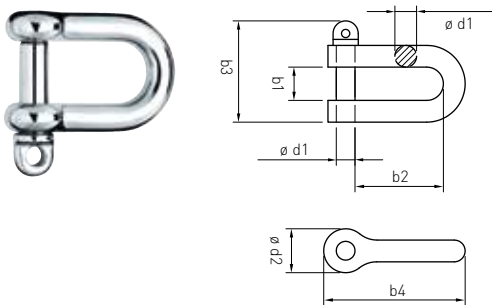

Artikelnummer Part number	Größe Size	$\varnothing d1$	b1	b2	b3	b4	$\varnothing d2$	WLL (to)
835-04	0,06	M4	8	16	24	26	9	0,16
835-05	0,10	M5	10	20	30	32	11	0,25
835-06	0,16	M6	12	24	34	38	12	0,375
835-08	0,25	M8	16	32	46	52	16	0,625
835-10	0,40	M10	20	40	56	66	20	1
835-12	0,60	M12	25	48	67	76	25	1,5
835-16	1,00	M16	32	64	88	101	32	2,75
835-20	1,60	M20	38	76	101	120	36	3,75

Werkstoff 1.4401 | Gemäß DIN82102 | WLL = Tragfähigkeit, gemäß Herstellerangaben
Material AISI 316 | According DIN82102 | WLL = Working load limit according manufacturer's data

SCHÄKEL, GESCHWEIFT_BOW SHACKLE

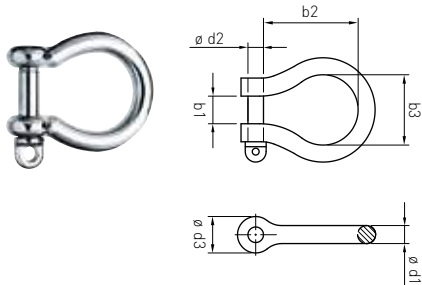

Artikelnummer Part number	Größe Size	$\varnothing d2$	b1	b2	b3	$\varnothing d1$	$\varnothing d3$	WLL (to)
835-04-01	0,60	M4	8	16	13	4	9	0,16
835-05-01	0,10	M5	10	20	14	5	11	0,25
835-06-01	0,16	M6	12	24	18	6	12	0,375
835-08-01	0,25	M8	16	32	24	8	16	0,625
835-10-01	0,40	M10	20	40	30	10	20	1
835-12-01	0,6	M12	25	45	36	12	24	1,5

Werkstoff 1.4401 | Gemäß DIN 82103 | WLL = Tragfähigkeit, gemäß Herstellerangaben

Material AISI 316 | According DIN 82103 | WLL = Working load limit according manufacturer's data

RINGSCHRAUBE_EYE BOLT

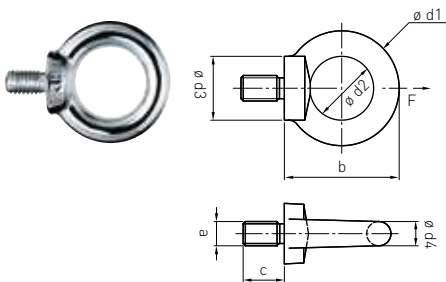

Artikelnummer Part number	a	b	c	$\varnothing d1$	$\varnothing d2$	$\varnothing d3$	$\varnothing d4$	MBK (kN)	F (kg)
837-0600-01*	M6	28	12	28	16	17	6	-	-
837-0600	M6	36	13	36	20	20	8-11	-	-
837-0800-01*	M8	36	13	36	20	20	8	-	-
837-0800	M8	36	13	36	20	20	8-11	8,2	140
837-1000-01*	M10	45	17	45	25	25	10	-	-
837-1000	M10	45	17	45	25	25	10-13	13,5	230
837-1200-01*	M12	53	21	54	30	30	12	-	-
837-1200	M12	53	21	54	30	30	12-15	20,0	340
837-1600	M16	62	27	63	35	35	14-17	41,2	700
837-2000	M20	71	30	72	40	40	16-19	70,6	1200
837-2400	M24	90	36	90	50	50	20-24	105,9	1800

Werkstoff 1.4401 | DIN 580 | geschmiedet

*Ähnlich DIN 580 | gegossen und poliert

MBK= Mindestbruchkraft

F = Tragfähigkeit

Material AISI316 | DIN 580 | drop-forged,

*casted and mirror polished

MBK= Breaking load

F = Working load limit

RINGMUTTER_EYE NUT

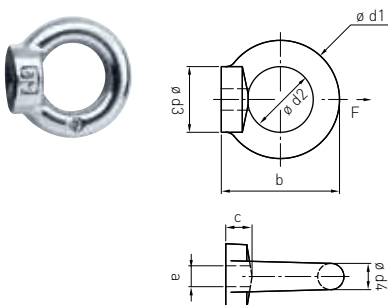

Artikelnummer Part number	a	b	c	$\varnothing d1$	$\varnothing d2$	$\varnothing d3$	$\varnothing d4$	MBK (kN)	F (kg)
838-0600-01*	M6	28	7	28	16	17	6	-	-
838-0600	M6	36	8	36	20	20	8-11	-	-
838-0800-01*	M8	36	8	36	20	20	8	-	-
838-0800	M8	36	8	36	20	20	8-11	8,2	140
838-1000-01*	M10	45	10	45	25	25	10	-	-
838-1000	M10	45	10	45	25	25	10-13	13,5	230
838-1200-01*	M12	53	11	54	30	30	12	-	-
838-1200	M12	53	11	54	30	30	12-15	20,0	340
838-1600	M16	62	13	63	35	35	14-17	41,2	700
838-2000	M20	71	15	72	40	40	16-19	70,6	1200
838-2400	M24	90	20	90	50	50	20-24	105,9	1800

Werkstoff 1.4401 | DIN 582 | geschmiedet

*Ähnlich DIN 582 | gegossen und poliert

MBK= Mindestbruchkraft

F = Tragfähigkeit

Material AISI316 | DIN 582 | drop-forged

*casted and mirror polished

MBK= Breaking load

F = Working load limit

ABDECKSCHEIBE MIT INNENGEWINDE ODER DURCHGANGSLOCH_COVER DISK WITH INTERNAL THREAD OR THROUGH HOLE

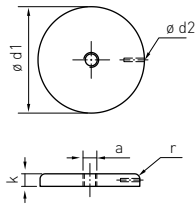

Artikelnummer Rechtsgewinde Part number RH thread	Artikelnummer Linksgewinde Part number LH thread	a	$\varnothing d1$	$\varnothing d2$	r	k
836-0500-05	836-0500-06	M5	35	1,5	2,5	4
836-0600-05	836-0600-06	M6	35	1,5	2,5	4
836-0800-05	836-0800-06	M8	50	3,5	3	6
836-1000-05	836-1000-06	M10	50	3,5	3	6
836-1300-50		$\varnothing 13$	50	-	3	6
836-0800-80		M8	80	3,5	3	6
836-1200-80		M12	80	3,5	3	6
836-0800-70		$\varnothing 8,1$	70	-	-	6

Werkstoff 1.4404_Material AISI 316L

SCHEIBE_WASHER

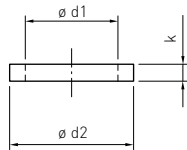

Artikelnummer Part number	k	$\varnothing d1$	$\varnothing d2$
896-0400	0,5	M4	8
896-0500	1	M5	9
896-0600	1,6	M6	11
896-0800	1,6	M8	15
896-1000	1,6	M10	18
896-1200	2	M12	20
896-1400	2,5	M14	25
896-1600	2,5	M16	28
896-2000	3	M20	34
896-2200	3	M22	39
896-2400	4	M24	39
896-3000	4	M30	56

Werkstoff 1.4401_Material AISI 316

SCHEIBE FÜR HOLZ_WASHER FOR WOOD

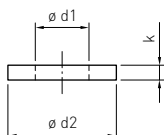

Artikelnummer Part number	k	$\varnothing d1$	$\varnothing d2$
896-0400-12	1	M4	12
896-0500-15	1,2	M5	15
896-0600-18	1,6	M6	18
896-0800-24	2	M8	24
896-1000-30	2,5	M10	30
896-1200-37	3	M12	37
896-1600-50	3	M16	50
896-2000-60	4	M20	60

Werkstoff 1.4404_Material AISI 316L

ZYLINDERSCHRAUBE_SOCKET HEAD SCREW

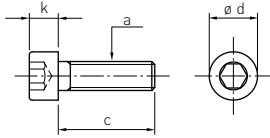

Artikelnummer Part number	a	c	k	ø d
844-0400	M4	25	4	7
844-0500	M5	25	5	8,5
844-0600	M6	30	6	10
844-0800	M8	35	8	13
844-1000	M10	40	10	16
844-1200	M12	50	12	18
844-1600	M16	60	16	24
844-2000	M20	70	20	30

Werkstoff 1.4401_Material AISI 316

BECHERSCHRAUBE_PAN HEAD SCREW

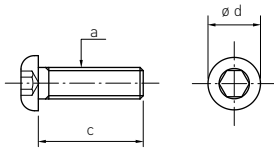

Artikelnummer Part number	a	c	ø d
890-0400-025	M4	25	7,5
890-0500-020	M5	20	9,5
890-0500-025	M5	25	9,5
890-0500-030	M5	30	9,5
890-0600-020	M6	20	10,5
890-0600-025	M6	25	10,5
890-0600-030	M6	30	10,5
890-0800-030	M8	30	14
890-0800-040	M8	40	14

Werkstoff 1.4401_Material AISI 316

STOCKSCHRAUBE_DUAL THREAD SCREW

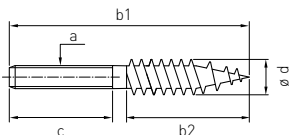

Artikelnummer Rechtsgewinde Part number RH thread	Artikelnummer Linksgewinde Part number LH thread	a	b1	b2	c	ø d
878-0500	877-0500	M5	50	30	20	4,3
878-0600	877-0600	M6	70	40	30	5,2
878-0800	877-0800	M8	100	60	40	6,9
878-0815	-	M8	50	30		6,9
878-1000	-	M10	61	35	22	8,9
878-1200	-	M12	110	60	30	12

Werkstoff 1.4401_Material AISI 316

SECHSKANTSCHRAUBE_HEXAGON HEAD SCREW

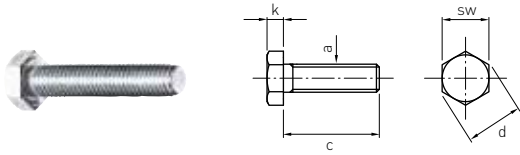



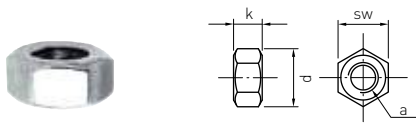

Artikelnummer Part number	a	c	k	sw	d
843-0400	M4	25	2,8	7	7,7
843-0500	M5	30	3,5	8	8,8
843-0600	M6	30	4	10	11,1
843-0800	M8	40	5,3	13	14,4
843-1000	M10	50	6,4	17	18,9
843-1060	M10	60	6,4	17	18,9
843-1200	M12	70	7,5	19	21,1
843-1400	M14	70	8,8	22	24,5
843-1600	M16	90	10	24	26,8
843-2000	M20	100	12,5	30	33,5

Werkstoff 1.4401_Material AISI 316

SECHSKANTMUTTER_HEXAGON NUT



Artikelnummer Rechtsgewinde Part number RH thread	Artikelnummer Linksgewinde Part number LH thread	a	k	sw	d
892-0400	893-0400	M4	3,2	7	7,7
892-0500	893-0500	M5	4	8	8,8
892-0600 	893-0600	M6	5	10	11,1
892-0800 	893-0800	M8	6,5	13	14,4
892-1000 	893-1000	M10	8	17	18,9
892-1200 	893-1200	M12	10	19	21,1
892-1400	893-1400	M14	11	22	24,5
892-1600	893-1600	M16	13	24	26,8
892-2000	893-2000	M20	16	30	33,5
892-2200	893-2200	M22	18	32	35
892-2400	893-2400	M24	19	36	39,5
892-2700	893-2700	M27	24	41	48
892-3000	893-3000	M30	24	46	50,8
892-3600	893-3600	M36	31	55	64

Werkstoff 1.4401_Material AISI 316

HUTMUTTER_DOME NUT

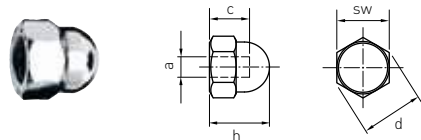

Artikelnummer Part number	a	c	h	sw	d
894-0400	M4	4,1	8	7	7,7
894-0500	M5	5,9	10	8	8,8
894-0600	M6	6	12	10	11,1
894-0800	M8	8,5	15	13	14,4
894-1000	M10	10	18	17	18,9
894-1200	M12	11,7	22	19	21,1
894-1400	M14	13	25	22	24,5
894-1600	M16	16	28	24	26,8
894-2000	M20	19,9	34	30	33,5

Werkstoff 1.4401_Material AISI 316

SICHERUNGSMUTTER_LOCK NUT WITH NYLON INSERT

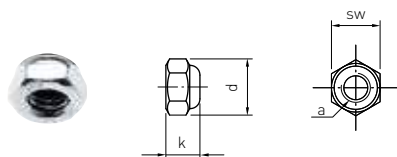

Artikelnummer Part number	a	k	sw	d
892-0400-02	M4	5	7	7,7
892-0500-02	M5	5	8	8,8
892-0600-02	M6	6	10	11,1
892-0800-02	M8	8	13	14,4
892-1000-02	M10	10	17	18,9
892-1200-02	M12	12	19	21,1
892-1400-02	M14	14	22	24,5
892-1600-02	M16	16	24	26,8
892-2000-02	M20	20	30	33,5

Werkstoff 1.4401_Material AISI 316

SPANNROHR, ZYLINDRISCH LINKS/RECHTS_TURNBUCKLE, CYLINDRICAL LEFT/ RIGHT

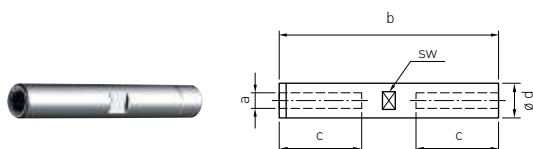

Artikelnummer Part number	a	b	c	sw	ø d
875-0500-01	M5	60	25	7	8
875-0500-02	M5	100	45	7	8
875-0600-01	M6	70	30	9	10
875-0600-02	M6	120	55	9	10
875-0800-01	M8	70	30	11	12
875-0800-02	M8	120	55	11	12

Werkstoff 1.4401_Material AISI 316

SPANNROHR LINKS/RECHTS_TURNBUCKLE LEFT/ RIGHT

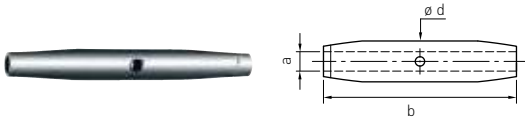

Artikelnummer Part number	a	b	ø d
875-0500	M5	80	8
875-0600	M6	92	10
875-0800	M8	112	13,5
875-1000	M10	120	17,2
875-1200	M12	150	21,3
875-1400	M14	170	21,3
875-1600	M16	190	26,9
875-2000	M20	220	33,7
875-2400	M24	328	50

Werkstoff 1.4401_Material AISI 316

GABELKONSOLE_FORK BRACKET

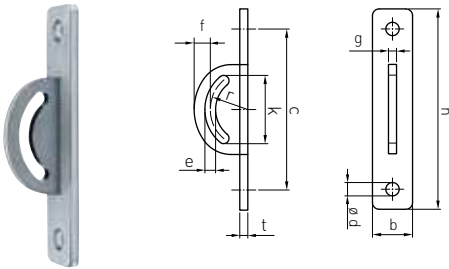

Artikelnummer Part number	b	c	ø d	e	f	g	h	k	r	t
834-006	30	120	12	8	12	6	150	51	28	6
834-012	53	210	14	14	28	12	262	89	49	12

Werkstoff 1.4404_Material AISI 316L

SEILABDECKUNG_WIRE ROPE END CAP



Artikelnummer Part number	b	ø d	ø Seil ø rope
904-0200	10,2	6,3	2
904-0300	8,8	5,5	3
904-0400	8,8	5,5	4
904-0500	8	7,5	5
904-0600	12	7,5	6
904-0800	13	11,5	8
904-1000	14,6	13,4	10

Kunststoff schwarz_Black plastic

GEWINDESTIFT_THREADED ROD

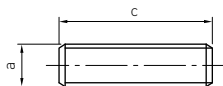

Werkstoff 1.4401_Material AISI 316

Artikelnummer Rechtsgewinde Part number RH thread	Artikelnummer Linksgewinde Part number LH thread	a	c
882-0500-060	883-0500-060	M5	60
882-0500-100	883-0500-100	M5	100
882-0500-1000	883-0500-1000	M5	1000
882-0600-060	883-0600-060	M6	60
882-0600-100	883-0600-100	M6	100
882-0600-1000	883-0600-1000	M6	1000
882-0800-060	883-0800-060	M8	60
882-0800-120	883-0800-120	M8	120
882-0800-220	883-0800-220	M8	220
882-0800-1000	883-0800-1000	M8	1000
882-1000-040	-	M10	40
882-1000-060	883-1000-060	M10	60
882-1000-1000	883-1000-1000	M10	1000
882-1200-040	-	M12	40
882-1200-080	883-1200-080	M12	80
882-1200-180	-	M12	180
882-1200-220	883-1200-220	M12	220
882-1200-1000	883-1200-1000	M12	1000
882-1600-080	883-1600-080	M16	80
882-1600-1000	883-1600-1000	M16	1000

SPANNBOLZEN RECHTS/LINKS_HEADLESS SCREW RH/LH

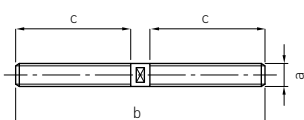

Werkstoff 1.4404_Material AISI 316L

Artikelnummer Part number	a	b	c
884-0400	M5	45	20
884-0500	M5	65	30
884-0600	M6	65	30
884-0800	M8	65	30
884-1000	M10	85	40
884-1200	M12	105	50
884-1400	M14	105	50
884-1600	M16	125	60
884-2000	M20	125	60

BOLZENANKER_WALL ANCHOR

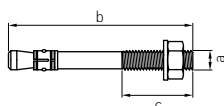

Werkstoff 1.4401_Material AISI 316

Artikelnummer Part number	a	b	c
803-0600-08	M6	67	20
803-0800-08	M8	75	25
803-1000-08	M10	80	30
803-1200-08	M12	180	80

Montageanleitung auf Anforderung_Assembly instructions on request

BOLZENANKER Z-IG A4_WALL ANCHOR Z-IG A4

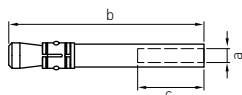

Artikelnummer Part number	a	b	c
803-0600-07	M6	50	20
803-0800-07	M8	62	22
803-1000-07	M10	70	23
803-1200-07	M12	86	27

Werkstoff 1.4401 | Montageanleitung auf Anforderung
Material AISI 316 | Assembly instructions on request

EINSCHRAUBMUFFE RAMPA® FÜR HOLZ_RAMPA® SCREW FOR WOOD

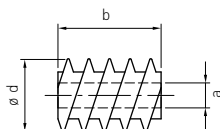

Artikelnummer Part number	a	b	ø d	ø x, Vorbohrung ø x, pilot hole
803-0400-04	M4	12	8	6,9
803-0500-04	M5	14	10	8,9
803-0600-04	M6	15	12	10,4
803-0601-04	M6	25	12	10,4
803-0800-04	M8	18	16	14,5
803-0801-04	M8	30	16	14,5
803-1000-04	M10	25	18,5	16,7
803-1001-04	M10	40	18,5	16,7

Stahl, blau verzinkt | Innensechskant Typ SK (~DIN 7965)
Blue galvanised steel | Type SK hexagon socket (~DIN 7965)

KUNSTSTOFFDÜBEL FÜR STOCKSCHRAUBE_PLASTIC WALL PLUG FOR DUAL THREAD SCREW



Artikelnummer Part number	c	b x d	ø S
803-0700-03	20	6 x 36	4,3-5
803-0800-03	22	8 x 51	5-6
803-1000-03	23	10 x 61	6-8

b x d = ø Bohrloch x Dübellänge
S = ø d1 Stockschraube
Montageanleitung auf Anforderung

b x d = ø Drill hole x Plug length
S = ø d1 dual thread screw
Assembly instructions on request

SIEBHÜLSE VM-SH FÜR HOHLSTEINE_PERFORATED SLEEVE VM-SH FOR HOLLOW STONES



Artikelnummer Part number	Für Gewinde For Threads
803-68	M6-M8
803-812	M8-M12

Kunststoff | Montageanleitung auf Anforderung
Plastic | Assembly instructions on request

THERMOANKER MIT SIEBHÜLSE_THERMO ANCHOR WITH PERFO SLEEVE

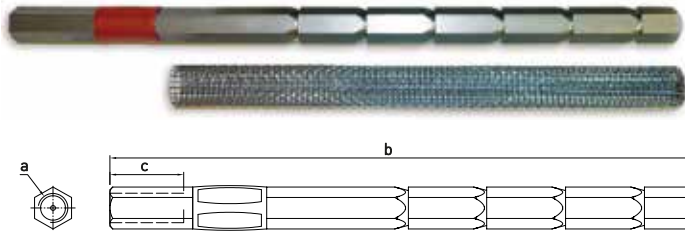

Artikelnummer Part number	a	b	c	S	D	Mörtelmenge Amount of mortar
803-1000-330	M10	330	15	150	170	100ml
803-1200-330	M12	330	15	150	170	100ml
803-1000-370	M10	370	15	150	210	120ml
803-1200-370	M12	370	15	150	210	120ml

Werkstoff 1.4404, genaue Montageanleitung beachten | S= min. Setztiefe im Mauerwerk | D= max. Dämmstoffstärke | Nur zugelassen mit Injektionsmörtel 803-501

Material AISI 316, observe exact installation instructions | S=min. installation depth | D= max. wide of insulation | Only approved with injection mortar 803-501

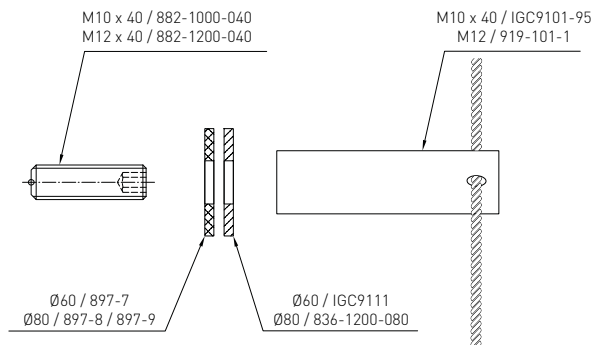
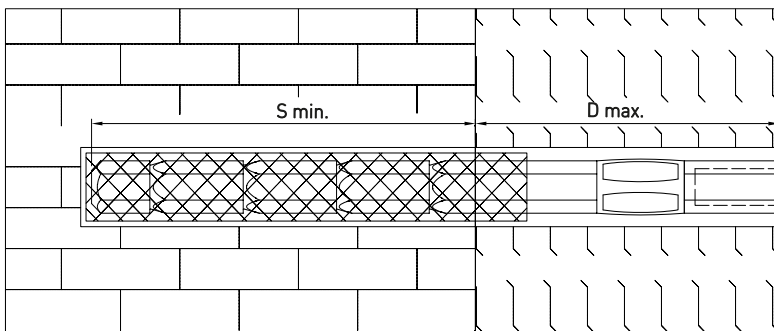

Beispiel 1_Example 1

Beispiel 1
Example 1

Ankersystem mit passenden Bauteilen aus der Fassadenbegrünung.

Anchor system with suitable items for green wall solutions.

HILFSMITTEL

AUXILIARY MATERIAL

DRAHTSEILSCHERE_WIRE ROPE CUTTER



Artikelnummer Part number	Länge Length	Ø Seil Ø rope
T00005	190	5
T00008	500	8

GEWINDESICHERUNG_THREAD LOCK FLUID



Artikelnummer Part number	Inhalt Contents
879-0001	50 ml

Lackähnlicher Überzug aus zwei mikroverkapselten Komponenten eines modifizierten Acrylat-Systems. Die Verbindung ist absolut dicht und vibrationsfest. So wird die Spannung aufrechterhalten und die Verbindung kann sich nicht selbstständig lösen. Gewindegewissung ist Bestandteil des Verbindungselements.

Lacquer-type coating comprised of two micro-encapsulated components of a modified acrylate system. The connection is completely sealed and vibration-proof. This ensures that the tension is maintained and the fastener cannot work loose of its own accord. The thread lock is an integral part of the fastener.

SPEZIALKLEBER FÜR METALL_SPECIAL ADHESIVE FOR METAL



Artikelnummer Part number	Inhalt Contents
879-0003	50 ml

Spezialkleber zur Befestigung von zylindrischen Teilen mit hoher Festigkeit, z. B. verschiebbaren Seilhülsen. Einsatzbereich -50 °C bis +150 °C, Endfestigkeit nach 12 Stunden.

Special adhesive for metal: For fixing of high-strength cylindrical parts e.g. movable cable sleeves. Temperature range -50 °C to +150 °C, final fixing after 12 hours.

INJEKTIONSMÖRTEL_INJECTION MORTAR



Artikelnummer Part number	Inhalt Contents	Typ Type
803-150	150 ml	VM-U
803-345	280 ml	VM-U
803-500*	500ml	HIT-HY 200-A500/2
803-501*	500ml	HIT-MM PLUS 500/2

VM-U Mörtel: auf Vinylesterbasis, styrolfrei. *Für den HIT-Mörtel wird das Auspressgerät HDM 500 benötigt/ nicht im Lieferumfang enthalten

VM-U mortar: on vinyl ester base, styrene free. *For the HIT mortar, a manual dispenser HDM 500 is needed/ is not included

GEPRÜFTE SICHERHEIT

TESTED SAFETY

Geprüfte Sicherheit mit dem CE-Zeichen bietet Vorteile für Konstruktion und architektonische Umsetzung. Sie beschleunigt Genehmigungen, reduziert Kosten und schafft damit für Bauherren, Planer und Prüfsingenieure eine große Realisierungssicherheit für das jeweilige Bauvorhaben.

Im Rahmen der bauaufsichtlichen bzw. Europäischen Technischen Zulassung finden eine kontinuierliche werksseitige Produktionskontrolle nach Prüf- und Überwachungsplan sowie regelmäßige Überwachungen durch unabhängige Prüfinstitute statt.

Tested safety with the CE mark has a number of advantages when it comes to planning and realising architectural projects. It speeds up the approval process and helps cut costs, leading to more dependable implementation for clients, planners and inspection engineers.

Continuous factory production controls in accordance with a prescribed test plan are backed up by regular inspections by independent testing institutes to determine compliance with general planning approvals and the European Technical Approval.



ANNAHME BEZÜGLICH DER BEMESSUNG VON SEILZUGGLIEDERN MIT ENDVERANKERUNGEN GEMÄSS ETA-10/0358

ASSUMPTIONS CONCERNING DESIGN OF WIRE ROPES WITH END CONNECTORS ACC. ETA-10/0358

Seilkonstruktion rope construction	Seil Ø rope Ø	F_{min} [kN]	k_e [-]	F_{uk} [kN]	F_{Rd} [kN]
1 x 19	6	29,70	0,9	26,73	17,82
1 x 19	8	52,80	0,9	47,52	31,68
1 x 19	10	82,50	0,9	74,25	49,50
1 x 19	12	118,70	0,82	97,33	64,89
1 x 19	14	161,60	0,82	132,51	88,34
1 x 37	16	192,90	0,88	169,75	113,17
1 x 37	18	244,00	0,88	214,72	143,15
1 x 61	22	364,60	0,78	284,39	189,59
1 x 61	26	509,30	0,78	397,25	264,84
7 x 19	6	20,50	0,9	18,45	12,30
7 x 19	8	36,40	0,9	32,76	21,84
7 x 19	10	56,80	0,85	48,28	32,19
7 x 19	12	81,80	0,9	73,62	49,08
7 x 19	14	111,40	0,9	100,26	66,84

Legende_Explanation:

Bezeichnung TermTe	Formel Formula	Beschreibung Specification
F_{min}	-	Mindestbruchlast des Seils Minimum breaking force
k_e	-	Verlustfaktor aufgrund der Endverankerungen Loss factor due to end connectors
F_{uk}	$F_{min} \times k_e$	Bruchfestigkeit der Seile inkl. Endverankerung Breaking strength of the wire ropes incl. end connectors
F_{Rd}	$F_{uk} / (1,5 \times \gamma_R)$	Grenzzugkraft der Seile inkl. Endverankerung Tension resistance of the wire ropes incl. end connectors
γ_R	1,0	Teilsicherheitsbeiwert ist gemäß der ETA empfohlen. Partial safety factor γ_R is a recommended value accord. to ETA.

Merkmale Attributes	<ul style="list-style-type: none"> — Europäische Technische Zulassung — Große Palette an Seilen \varnothing 6–26 mm — Sinnvoll abgestimmte Seilverbindungen — Höchstmögliche Kraftübertragung bei kleinstmöglichen Querschnitten — Bewährte Verpresstechnik mit hoher Sicherheit — European Technical Approval — Wide range of cable diameters from 6 to 26 mm — Optimally coordinated cable combinations — Maximum power transmission, minimum cross-sections — Proven swaging technology guarantees the highest possible safety
Bemessungswerte Design values	<p>Alle Bauteile können über die Bruchkraft F_{uk} sortiert werden. Die jeweiligen Verlustfaktoren sind bereits berücksichtigt. Die Berechnung zur notwendigen Grenzzugkraft F_{Rd} finden Sie in den Tabellen der Zulassung, länderspezifische Normen sind dabei zu berücksichtigen.</p> <p>All parts can be sorted according to the breaking load F_{uk}. The loss factors are already incorporated. The calculation of the required tension resistance F_{Rd} can be found in the tables in the assessment; national standards have to be considered.</p>

KOMPONENTEN

COMPONENTS

SPANNSCHLOSS MIT GABELFITTING_TURNBUCKLE WITH FORK FITTING



Artikelnummer Part number	a	b	e	f	g	ø d	ø d1	ø Seil ø rope	Spannweg Adjustment	l1	l2	ø l
670-0600	M10	231	14	18	10	12,5	10	6	+13 -43	8	17	10,3
670-0800	M12	307	16	24	12	16,1	12	8	+22 -58	10	20	12,3
670-1000	M14	346	20	29	14	17,8	16	10	+31 -73	12	26	16,3
670-1200	M16	458	25	35	17	21,4	20	12	+39 -87	15	33	20,3
670-1400	M20	535	28	41	20	24,9	23	14	+46 -106	18	38	23,3
670-1600	M24	644	33	48	22	28	26	16	+60 -126	20	42	26,3
670-1800	M27	712	38	53	28	34,5	29	18	+54 -135	25	48	29,3
670-2200	M30	850	40	61	30	40,3	33	22	+74 -164	25	56	33,3
670-2600	M36	913	45	71	33	45,9	36	26	+56 -164	30	60	36,3

Werkstoff 1.4401 | Europäische Technische Zulassung erteilt | Bruchkraft siehe Kapiteleinstieg

Material AISI 316 | European Technical Approval granted | for breaking load, see introduction of the chapter

GABELFITTING, AUFGEROLLT_FORK, ROLL SWAGED

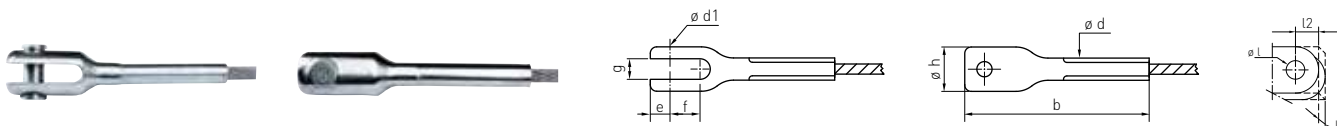

Artikelnummer Part number	b	e	f	g	h	ø d	ø d1	ø Seil ø rope	l1	l2	ø l
681-0600	116	14	18	10	22	12,5	10	6	8	17	10,3
681-0800	151	16	24	12	28	16,1	12	8	10	20	12,3
681-1000	185	20	29	14	34	17,8	16	10	12	26	16,3
681-1200	220	25	35	17	41	21,4	20	12	15	33	20,3
681-1400	238	28	41	20	48	24,9	23	14	18	38	23,3
681-1600	286	33	48	22	55	28	26	16	20	42	26,3
681-1800	335	38	53	28	70	34,5	29	18	25	48	29,3
681-2200	379	40	61	30	72	40,3	33	22	25	56	33,3
681-2600	445	45	71	33	83	45,9	36	26	30	60	36,3

Werkstoff 1.4401 | Europäische Technische Zulassung erteilt | Bruchkraft siehe Kapiteleinstieg

Material AISI 316 | European Technical Approval granted | for breaking load, see introduction of the chapter

GEWINDEFITTING, AUFGEROLLT_EXTERNAL THREAD, ROLL SWAGED



Artikelnummer Rechtsgewinde Part number RH thread	Artikelnummer Linksgewinde Part number LH thread	a	b	c	ø d	ø Seil ø rope
650-0600-045	655-0600-045	M10	117	45	12,5	6
650-0800-060	655-0800-060	M12	156	60	16,1	8
650-1000-076	655-1000-076	M14	193	76	17,8	10
650-1200-090	655-1200-090	M16	232	90	21,4	12
650-1400-110	655-1400-110	M20	259	110	24,9	14
650-1600-130	655-1600-130	M24	313	130	28	16
650-1800-140	655-1800-140	M27	357	140	34,5	18
650-2200-170	655-2200-170	M30	430	170	40,3	22
650-2600-170	655-2600-170	M36	475	170	45,9	26

Werkstoff 1.4401 | Europäische Technische Zulassung erteilt | Bruchkraft siehe Kapiteleinstieg

Material AISI 316 | European Technical Approval granted | for breaking load, see introduction of the chapter

SPANNSCHLOSS, AUFGEROLLT_TURNBUCKLE, ROLL SWAGED

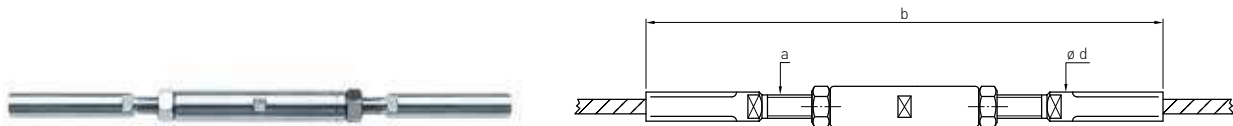

Artikelnummer Part number	a	b	Spannweg Adjustment	ø d	ø Seil ø rope
625-0600-02	M10	279	±22	12,5	6
625-0800-02	M12	356	±30	16,1	8
625-1000-02	M14	446	±38	17,8	10
625-1200-02	M16	532	±45	21,4	12
625-1400-02	M20	604	±55	24,9	14
625-1600-02	M24	726	±65	28	16
625-1800-02	M27	818	±70	34,5	18
625-2200-02	M30	992	±85	40,3	22
625-2600-02	M36	1082	±285	45,9	26

Werkstoff 1.4401 | Europäische Technische Zulassung erteilt | Bruchkraft siehe Kapiteleinstieg

Material AISI 316 | European Technical Approval granted | for breaking load, see introduction of the chapter

SPANNROHR_TURNBUCKLE

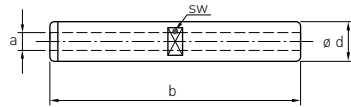

Artikelnummer Part number	a	b	sw	ø d
675-1000	M10	90	17	19
675-1200	M12	104	18	20
675-1400	M14	136	22	25
675-1600	M16	156	24	28
675-2000	M20	196	28	32
675-2400	M24	230	36	40
675-2700	M27	244	41	48
675-3000	M30	302	46	54
675-3600	M36	302	55	60

Werkstoff 1.4401 | Europäische Technische Zulassung erteilt | Bruchkraft siehe Kapiteleinstieg

Material AISI 316 | European Technical Approval granted | for breaking load, see introduction of the chapter

GABEL MIT AUSSENGEWINDE_FORK WITH EXTERNAL THREAD

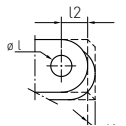
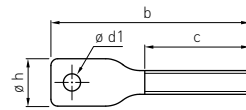
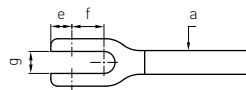

Artikelnummer Rechtsgewinde Part number RH thread	Artikelnummer Linksgewinde Part number LH thread	a	b	c	ø d1	e	f	g	ø h	l1	l2	ø l
671-1000	672-1000	M10	93	43	10	14	18	10	22	8	17	10,3
671-1200	672-1200	M12	121	56	12	16	24	12	28	10	20	12,3
671-1400	672-1400	M14	148	71	16	20	29	14	34	12	26	16,3
671-1600	672-1600	M16	180	84	20	25	35	17	41	15	33	20,3
671-2000	672-2000	M20	214	102	23	28	41	20	48	18	38	23,3
671-2400	672-2400	M24	260	122	26	33	48	22	55	20	42	26,3
671-2700	672-2700	M27	284	131	29	38	53	28	70	25	48	29,3
671-3000	672-3000	M30	322	159	33	40	61	30	72	25	56	33,3
671-3600	672-3600	M36	346	159	36	45	71	33	83	30	60	36,3

Werkstoff 1.4401 | Europäische Technische Zulassung erteilt | Bruchkraft siehe Kapiteleinstieg

Material AISI 316 | European Technical Approval granted | for breaking load, see introduction of the chapter

KONFEKTIONEN: ZULASSUNGEN

ASSEMBLY DRAWINGS: APPROVALS

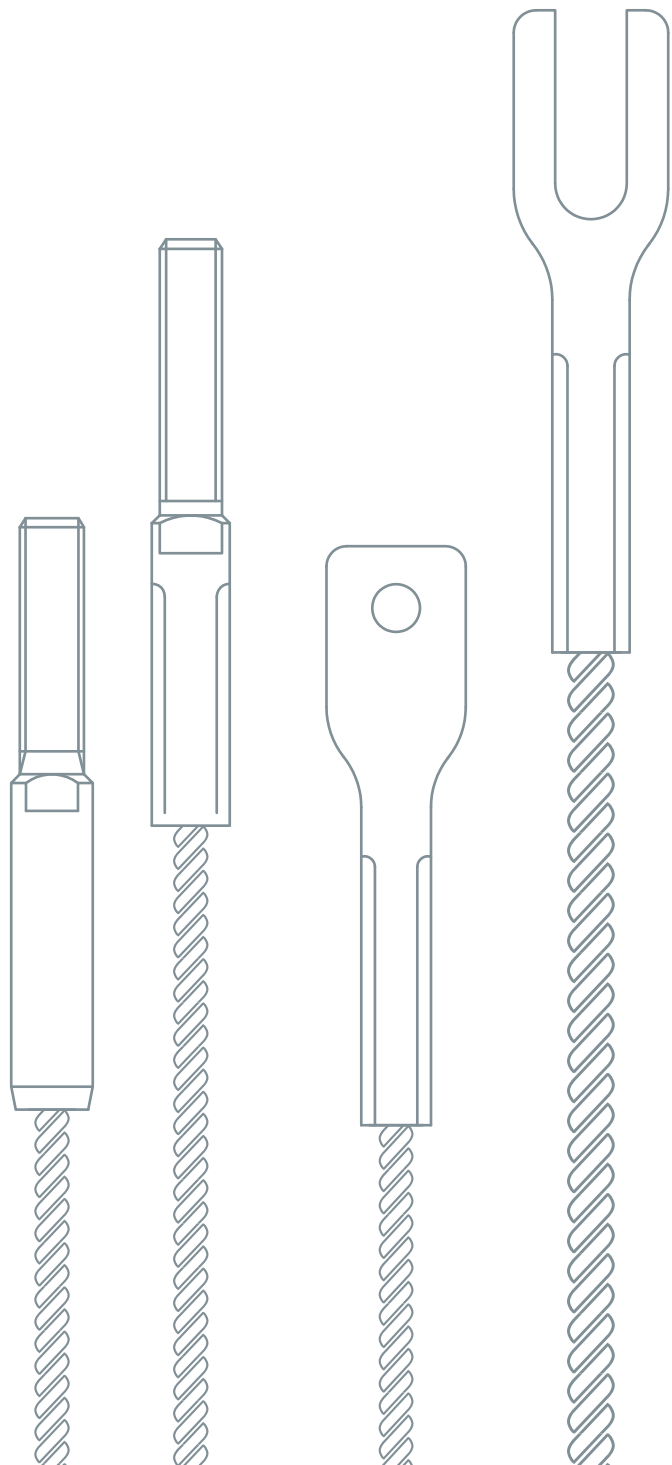

BEIDE SEITEN AUSSENGEWINDE, AUFGEROLLT_BOTH SIDE EXTERNAL THREAD, ROLLED

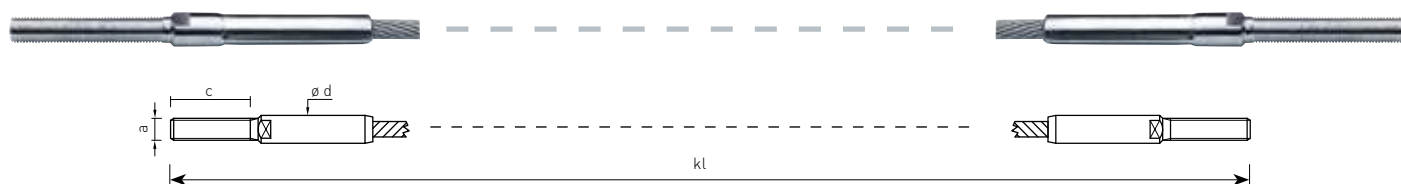

Artikelnummer Beide Seiten Rechtsgewinde Part number both sides RH thread	ø Seil ø rope	a	c	ø d	KL min
IKZ600-0600	6	M10	45	12,5	600
IKZ600-0800	8	M12	60	16,1	800
IKZ600-1000	10	M14	76	17,8	1000
IKZ600-1200	12	M16	90	21,4	1200
IKZ600-1400	14	M20	110	24,9	1400
IKZ600-1600	16	M24	130	28	1600
IKZ600-1800	18	M27	140	34,5	1800
IKZ600-2200	22	M30	170	40,3	2200
IKZ600-2600	26	M36	170	45,9	2600

KL min = Mindestkonfektionslänge bei Spiralseil | Bruchkraft siehe Kapiteleinstieg

KL min= minimal length for strand | for breaking load, see introduction of the chapter

BEIDE SEITEN MIT SPANNSCHLOSS UND GABELFITTING_BOTH SIDE TURNBUCKLE WITH FORK FITTING

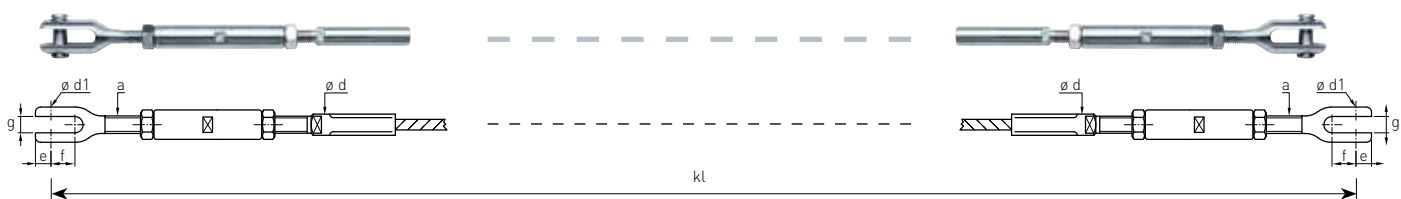

Artikelnummer Part number	ø Seil ø rope	a	e	f	g	ø d	ø d1	KL min
IKZ604-0600	6	M10	14	18	10	12,5	10	600
IKZ604-0800	8	M12	16	24	12	16,1	12	800
IKZ604-1000	10	M14	20	29	14	17,8	16	1000
IKZ604-1200	12	M16	25	35	17	21,4	20	1200
IKZ604-1400	14	M20	28	41	20	24,9	23	1400
IKZ604-1600	16	M24	33	48	22	28	26	1600
IKZ604-1800	18	M27	38	53	28	34,5	29	1800
IKZ604-2200	22	M30	40	61	30	40,3	33	2200
IKZ604-2600	26	M36	45	71	33	45,9	36	2600

KL min = Mindestkonfektionslänge bei Spiralseil | Bruchkraft siehe Kapiteleinstieg

KL min= minimal length for strand | for breaking load, see introduction of the chapter

EINE SEITE SPANNSCHLOSS MIT GABEL, ANDERE SEITE GABEL, AUFGEROLLT

ONE SIDE TURNBUCKLE WITH FORK, OTHER SIDE FORK SWAGED

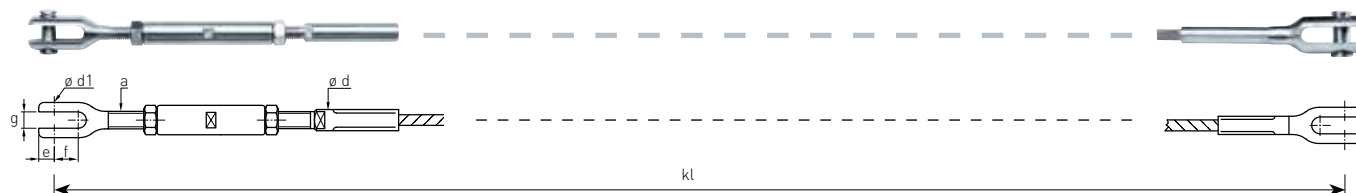

Artikelnummer Part number	ø Seil ø rope	a	e	f	g	ø d	ø d1	KL min
IKZ605-0600	6	M10	14	18	10	12,5	10	600
IKZ605-0800	8	M12	16	24	12	16,1	12	800
IKZ605-1000	10	M14	20	29	14	17,8	16	1000
IKZ605-1200	12	M16	25	35	17	21,4	20	1200
IKZ605-1400	14	M20	28	41	20	24,9	23	1400
IKZ605-1600	16	M24	33	48	22	28	26	1600
IKZ605-1800	18	M27	38	53	28	34,5	29	1800
IKZ605-2200	22	M30	40	61	30	40,3	33	2200
IKZ605-2600	26	M36	45	71	33	45,9	36	2600

KL min = Mindestkonfektionslänge bei Spiralseil | Bruchkraft siehe Kapiteleinstieg

KL min= minimal length for strand | for breaking load, see introduction of the chapter

BEIDE SEITEN MIT GABELFITTING, AUFGEROLLT_BOTH SIDE WITH FORK FITTING, ROLLED

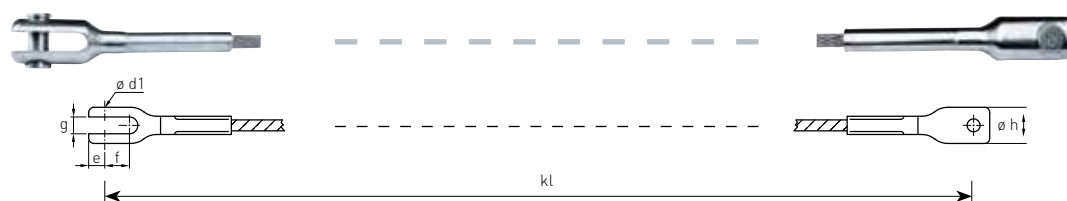

Artikelnummer Part number	ø Seil ø rope	a	e	f	g	ø d1	ø h	KL min
IKZ607-0600	6	M10	14	18	10	10	22	600
IKZ607-0800	8	M12	16	24	12	12	28	800
IKZ607-1000	10	M14	20	29	14	16	34	1000
IKZ607-1200	12	M16	25	35	17	20	41	1200
IKZ607-1400	14	M20	28	41	20	23	48	1400
IKZ607-1600	16	M24	33	48	22	26	55	1600
IKZ607-1800	18	M27	38	53	28	29	70	1800
IKZ607-2200	22	M30	40	61	30	33	72	2200
IKZ607-2600	26	M36	45	71	33	36	83	2600

KL min = Mindestkonfektionslänge bei Spiralseil | Bruchkraft siehe Kapiteleinstieg

KL min= minimal length for strand | for breaking load, see introduction of the chapter

HÄNGENDE GÄRTEN AM HAUS

HOUSE WITH A HANGING GARDEN

Grüne Fassaden sind Ausdruck verantwortlichen Umgangs mit der Natur, sie bereichern unser tägliches Lebensumfeld. Das hochwertige Ranksystem aus den I-SYS Edelstahl-Elementen spendet Schatten, schützt vor Kälte und bindet Feinstaub. Die grüne Wand verbindet Gesundheit mit Wirtschaftlichkeit und Ästhetik. Begrünte Fassaden helfen, das Arbeits- und Wohnumfeld freundlicher und menschlicher zu gestalten. Sie bringen Naturerlebnisse und die Wahrnehmung unserer Jahreszeiten zurück. Dort, wo Pflanzen wachsen, Blumen blühen und Vögel leben, fühlt sich auch der Mensch wohl.

Green façades are an expression of responsible interaction with the environment and an enrichment of our daily lives. Our high-quality climbing structures made from I-SYS stainless steel elements offer shade, keep out the cold and bind fine dust particles. Green wall systems unite health and vitality with cost efficiency and aesthetics. Greened façades help make daily work and living environments more ecologically compatible and more humane. They provide a great opportunity to experience nature directly and appreciate the changing of the seasons. A place where plants grow, flowers bloom and birds play is an oasis of well-being for people too.

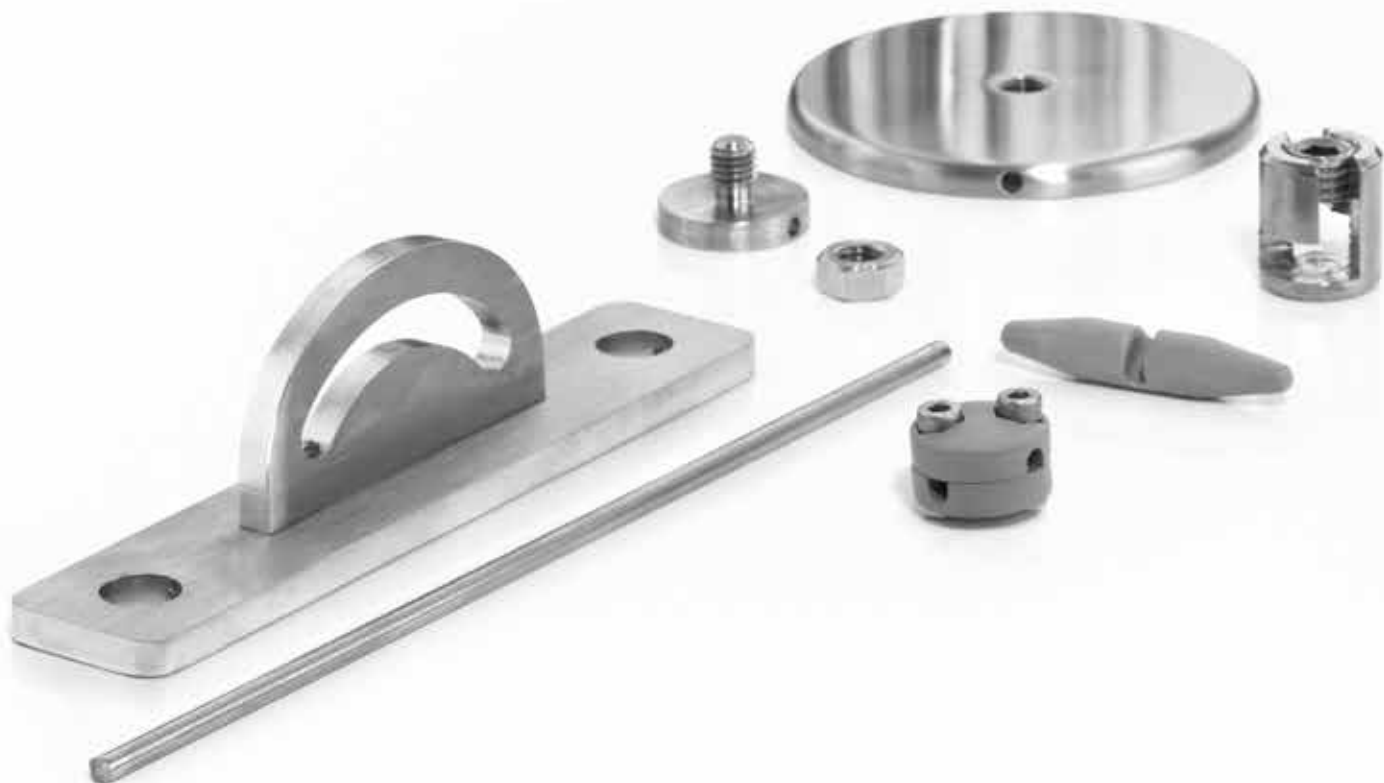



<p>Merkmale Attributes</p>	<ul style="list-style-type: none"> — Hochwertige Bauteile aus A4-Edelstahl — Wartungsarm und langlebig — Vielzahl an Gestaltungselementen — Variabel und modular erweiterbar — High-quality parts made from A4 stainless steel — Extremely durable, virtually no maintenance required — Numerous design elements — Variable, modular system
---------------------------------------	---

KOMPONENTEN

COMPONENTS

DISTANZHÜLSE_SPACER BAR

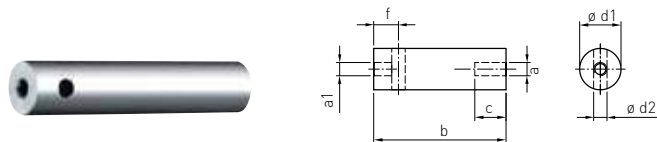

Artikelnummer Part number	a	a1	b	c	ø d1	ø d2	f
919-080	M8	M8	80	20	25	8,1	15
919-120	M8	M8	120	20	25	8,1	15
919-120-12	M12	M8	120	25	25	8,5	15
919-160	M8	M8	160	20	25	8,1	15

Werkstoff 1.4404_Material AISI 316L

SEILKREUZHALTER_CROSS CLAMP SPACER BAR

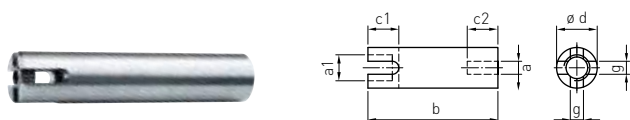

Artikelnummer Part number	a	a1	b	c1	c2	ø d	g
919-061	M8	M12	83	22	20	25	6,5
919-101	M8	M12	123	22	20	25	6,5
919-101-12	M12	M12	123	22	25	25	6,5
919-141	M8	M12	163	22	20	25	6,5

Werkstoff 1.4404_Material AISI 316L

KLEMSCHRAUBE_CLAMP SCREW

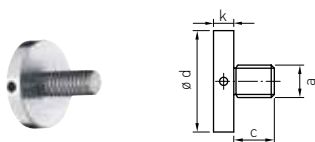

Artikelnummer Part number	a	c	ø d	k
923-0800-10	M8	10	25	5
923-0800-17	M8	17	25	5
923-0800-22	M8	22	25	5
923-1200-10	M12	10	25	5
923-1200-15	M12	15	25	5

Werkstoff 1.4404 | Auch als Überlastsicherung einsetzbar_Material AISI 316L | Also usable for overload protection

LOCHSCHEIBE_CONNECTION DISC

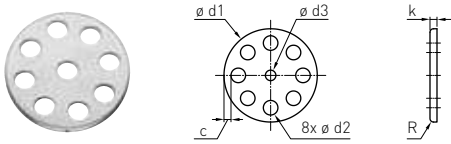

Artikelnummer Part number	ø d1	ø d2	ø d3	c	k	R
897-0080	80	12,5	9	6	6	3

Werkstoff 1.4404_Material AISI 316L

DICHTSCHEIBE_SEALING DISK

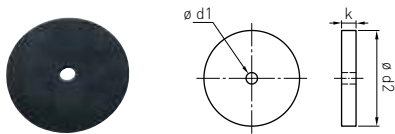

Artikelnummer Part number	ø d1	ø d2	k	Werkstoff Material
897-7	12	60	5	EPDM soft
897-8	12	80	5	EPDM soft
897-9	12	80	5	EPDM hard

CS-SEILKREUZ 90° AUS KUNSTSTOFF_CS-CROSS CLAMP 90°, PLASTIC

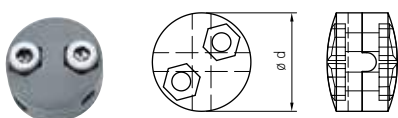

Artikelnummer Part number	ø Seil ø rope	ø d
920-0400	4	21

Kunststoff grau, UV-beständig_Grey plastic, UV-resistant

KLETTERSPROSSE AUS KUNSTSTOFF_CLIMBER STUD, PLASTIC



Artikelnummer Part number	ø Seil ø rope	b	ø d
924-0400	4	50	21

Kunststoff grau, UV-beständig_Grey plastic, UV-resistant

EDELSTAHLSTAB_STAINLESS STEEL ROD



Artikelnummer Part number	$\varnothing d$	kl max.
922-0400	4	2000

Werkstoff 1.4571_Material AISI 316Ti

ABDECKSCHEIBE MIT INNENGEWINDE_COVER DISK WITH INTERNAL THREAD

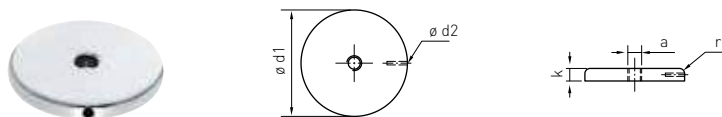

Artikelnummer Rechtsgewinde Part number RH thread	a	$\varnothing d1$	$\varnothing d2$	r	k
836-0800-80	M8	80	3,5	3	6
836-1200-80	M12	80	3,5	3	6

Werkstoff 1.4404_Material AISI 316L

GRUNDPLATTE_GROUND PLATE



Artikelnummer Part number	$\varnothing d1$	$\varnothing d2$	k
836-0800-70	70	8,1	6

Werkstoff 1.4404_Material AISI 316L

GABELKONSOLE_FORK BRACKET

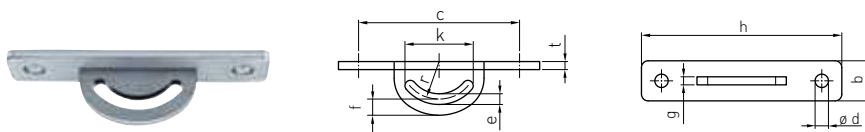

Artikelnummer Part number	b	c	$\varnothing d$	e	f	g	h	k	r	t
834-006	30	120	12	8	12	6	150	51	28	6
834-012	53	210	14	14	28	12	262	89	49	12

Werkstoff 1.4404_Material AISI 316L

SEILKREUZ, VERSTELLBAR_CROSS CLAMP ADJUSTABLE

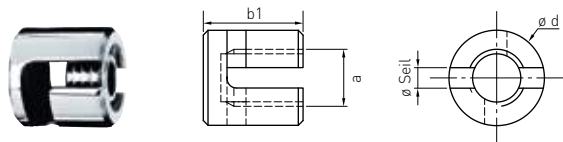

Artikelnummer Part number	ø Seil ø rope	a	b1	ø d
858-0400-01	4	M12	19,5	20

Werkstoff 1.4401_Material AISI 316

SEILKREUZ, VERSTELLBAR, MIT INNENGEWINDE_CROSS CLAMP WITH INTERNAL THREAD ADJUSTABLE

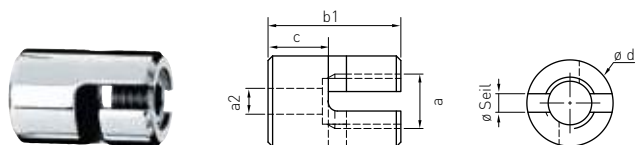

Artikelnummer Part number	ø Seil ø rope	a1	a2	b1	ø d	c
858-0400-02	4	M12	M8	31	20	15

Werkstoff 1.4401_Material AISI 316

SEILKREUZ 90°_CROSS CLAMP 90°

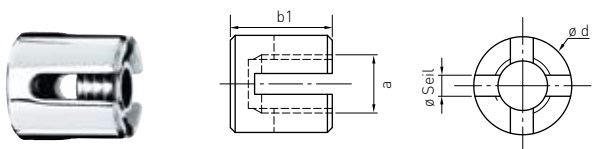

Artikelnummer Part number	ø Seil ø rope	a	b1	ø d
858-0400	4	M12	21	20

Werkstoff 1.4401_Material AISI 316

STOCKSCHRAUBE_DUAL THREAD SCREW

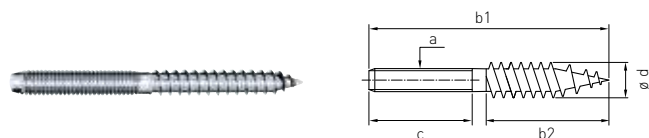

Artikelnummer Part number RH thread	a	b1	b2	c	ø d
878-0800	M8	100	60	40	6,9
878-1000	M10	61	35	22	8,9

Werkstoff 1.4401_Material AISI 316

GEWINDESTIFT_THREADED ROD



Artikelnummer Rechtsgewinde Part number RH thread	a	c
882-0800-060	M8	60
882-0800-120	M8	120
882-0800-220	M8	220
882-0800-1000	M8	1000
882-1000-060	M10	60
882-1000-120	M10	120
882-1000-220	M10	220
882-1000-1000	M10	1000
882-1200-080	M12	80
882-1200-180	M12	180
882-1200-220	M12	220
882-1200-1000	M12	1000

Werkstoff 1.4401_Material AISI 316

EINSCHRAUBMUFFE RAMPA® FÜR HOLZ_RAMPA® SCREW FOR WOOD

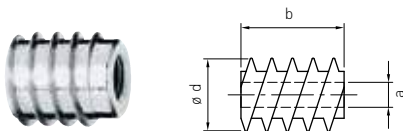

Artikelnummer Part number	a	b	ø d	ø x, Vorbohrung ø x, pilot hole
803-0600-04	M6	12	8	6,9
803-0800-04	M8	18	16	14,5
803-0801-04	M8	30	16	14,5
803-1000-04	M10	25	18,5	16,7
803-1001-04	M10	40	18,5	16,7

Stahl, blau verzinkt | Innensechskant Typ SK_Blue galvanised steel | Type SK hexagon socket

SECHSKANTMUTTER_HEXAGON NUT

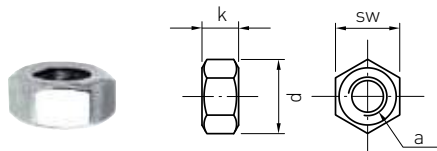

Artikelnummer Rechtsgewinde Part number RH thread	a	d	k	sw
892-0600	M6	11,1	5	10
892-0800	M8	14,4	6,5	13
892-1000	M10	18,9	8	17
892-1200	M12	21,1	10	19

Werkstoff 1.4401_Material AISI 316

RUNDLITZENSEIL 7 x 7_ROPE 7 x 7



Artikelnummer Part number	ø	kN	MQ mm ²
820-0400	4	8,94	6,85

Werkstoff 1.4401 | Eigenschaften: mittlere Flexibilität_Material AISI 316 | Characteristics: medium flexibility

RUNDLITZENSEIL 7 x 19_ROPE 7 x 19



Artikelnummer Part number	ø	kN	MQ mm ²
830-0400	4	8,34	6,63

Werkstoff 1.4401 | Eigenschaften: hohe Flexibilität_Material AISI 316 | Characteristics: high flexibility

SEILABDECKUNG_WIRE ROPE END CAP



Artikelnummer Part number	b	ø d	ø Seil ø rope
904-0400	8,8	5,5	4

Kunststoff schwarz_Black plastic

AUSSENGEWINDE, VERPRESST_EXTERNAL THREAD SWAGED

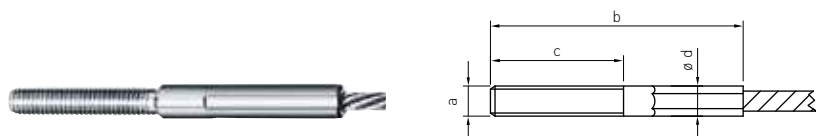

Artikelnummer Rechtsgewinde Part number RH thread	ø Seil ø rope	a	b	c	ø d	kN
850-0400-030	4	M6	75	30	7	11,2
850-0400-060	4	M6	105	60	7	11,2
850-0400-061	4	M8	105	60	8	11,2

Werkstoff 1.4404 | kN = Bruchkraft_Material AISI 316L | kN = breaking load

AUSSENGEWINDE, VERSCHRAUBT_EXTERNAL THREAD SWAGELESS CONNECTION

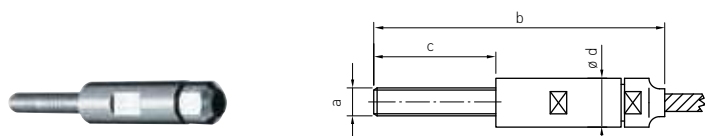

Artikelnummer Rechtsgewinde Part number RH thread	ø Seil ø rope	a	b	c	ø d	kN
826-0400-060	4	M6	115	60	13	8

Werkstoff 1.4404 | Nicht geeignet für Spiralseil 1 x 19 | kN = Bruchkraft_Material AISI 316L | Not suitable for strand 1 x 19 | kN = breaking load

SPANNSCHLOSS MIT GABEL, VERPRESST_TURNBUCKLE WITH FORK SWAGED

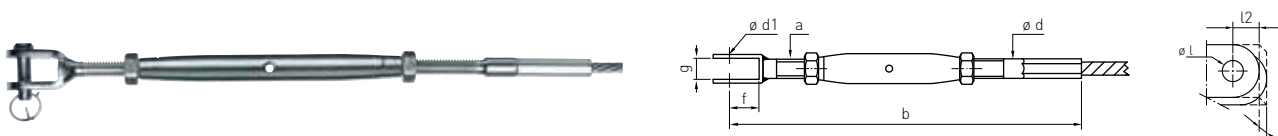

Artikelnummer Part number	ø Seil ø rope	a	b	ø d	ø d1	f	g	Spannweg Adjustment	kN	l1	l2	ø l
870-0401	4	M8	248	8	6	13	10	+34 -50	11,8	8	10	6,5

Werkstoff 1.4401 | kN = Bruchkraft_Material AISI 316 | kN = breaking load

GABEL, VERPRESST_FORK SWAGED

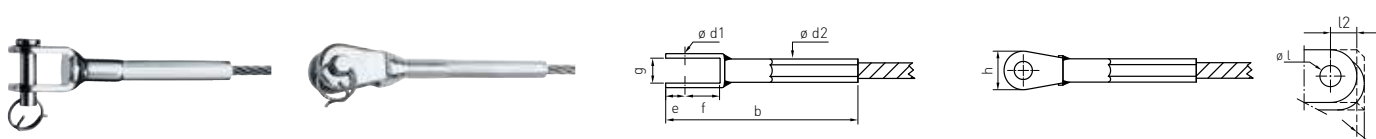

Artikelnummer Part number	ø Seil ø rope	b	ø d1	ø d2	e	f	g	h	kN	l1	l2	ø l
881-0400	4	80	6	7,5	7	13	10	14,5	9,5	8	10	6,5

Werkstoff 1.4401 | kN = Bruchkraft_Material AISI 316 | kN = breaking load

ALLE ANGABEN IN MILLIMETERN_ALL DIMENSIONS IN MILLIMETRES

MONTAGEBEISPIELE

INSTALLATION EXAMPLES

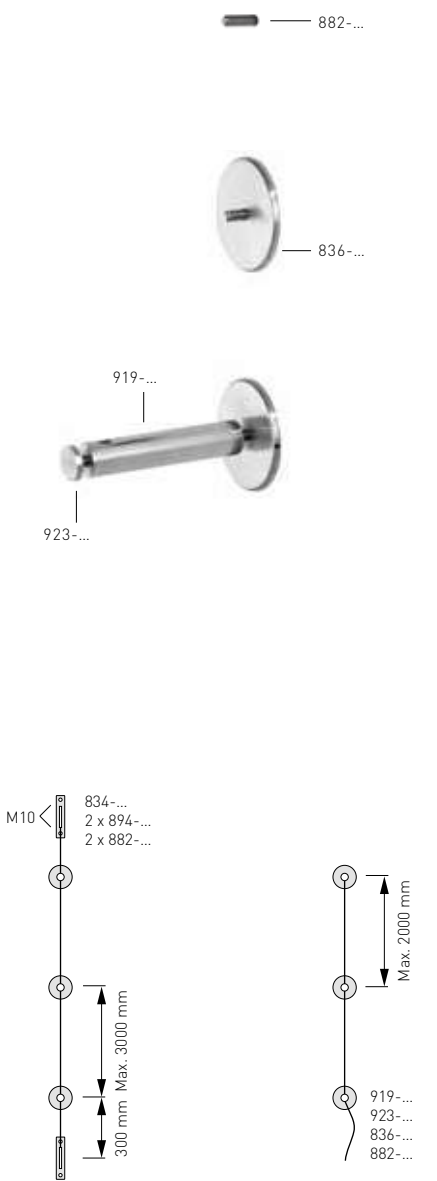

Beispiel 1_Example 1

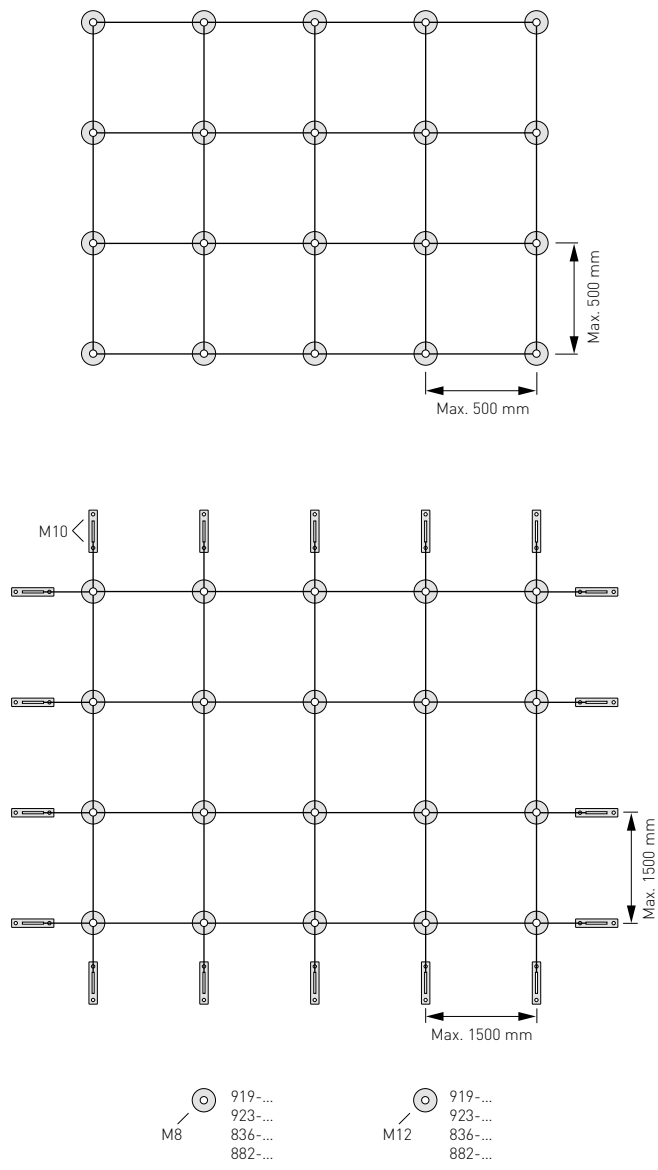

Beispiel 2_Example 2

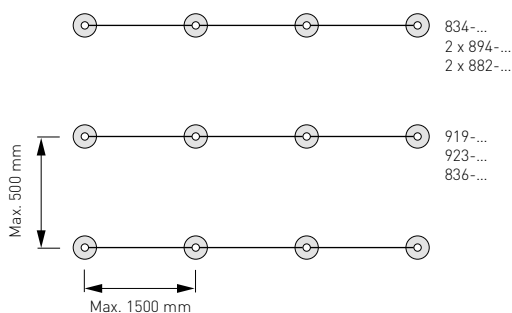

Beispiel 3_Example 3

<p>Beispiel 1 Example 1</p>	<p>Für Schlinger/Winder: Wisteria, Lonicera, Fallopia, Actinidia ...</p> <p>For Twining plants: Wisteria, lonicera, fallopia, actinidia ...</p>
<p>Beispiel 2 Example 2</p>	<p>Für Blattstielranker und Sprossranker: Clematis, Tropaeolum, Vitis, Ampelopsis ...</p> <p>For leaf stemmed climbers and shooting climbers: Clematis, tropaeolum, vitis, ampelopsis ...</p>
<p>Beispiel 3 Example 3</p>	<p>Für Spreizklimmer: Jasminum, Rosa, Rubus ...</p> <p>For leaf scrambling plants: Jasminum, rosa, rubus ...</p>

AUSFÜHRUNGSBEISPIELE

POSSIBLE LAYOUTS





5



6

- 1 Edelstahlseil 4 mm, 820-0400**
Beide Seiten Außengewinde, verpresst, 850-0400-060
 Stainless steel wire rope 4 mm, 820-0400
 Both sides external thread swaged, 850-0400-060
- 2 Edelstahlseil 4 mm, 820-0400**
Eine Seite Außengewinde, verpresst, 850-0400-060
Andere Seite Außengewinde, verschraubt, 826-0400-060
(Zur Selbstmontage vor Ort)
 Stainless steel wire rope 4 mm, 820-0400
 One side external thread swaged, 850-0400-060
 Other side external thread swageless connection, 826-0400-060
 (for self assembly on site)
- 3 Edelstahlseil 4 mm, 820-0400**
Eine Seite Außengewinde, verpresst, 850-0400-060
Andere Seite Seilende glatt mit Seilendkappe, 904-0400
 Stainless steel wire rope 4 mm, 820-0400
 One side external threadswaged, 850-0400-060
 Other side wire ropeend cap, 904-0400
- 4 Edelstahlseil 4 mm, 820-0400**
Beide Seiten Spannschloss mit Gabel, 870-0401
 Stainless steel wire rope 4 mm, 820-0400
 Both sides turnbuckle with fork swaged, 870-0401
- 5 Edelstahlseil 4 mm, 820-0400**
Eine Seite Gabel, verpresst, 881-0400
Andere Seite Spannschloss mit Gabel, 870-0401
 Stainless steel wire rope 4 mm, 820-0400
 One side fork swaged, 881-0400
 Other side turnbuckle with fork fitting, 870-0401
- 6 Edelstahlseil 4 mm, 820-0400**
Eine Seite Gabel, verpresst, 881-0400
Andere Seite Seilende glatt mit Seilendkappe, 904-0400
 Stainless steel wire rope 4 mm, 820-0400
 One side fork swaged, 881-0400
 Other side wire rope end cap, 904-0400

EIGNUNGSHINWEIS

SUITABILITY

Das I-SYS Ranksystem eignet sich vor allem für Schlinger und Winder. Durch die Verwendung der Gabelkonsole können hohe Kräfte in die Fassade eingeleitet werden. Werden die Seile am untersten Wandhalter nur handfest geklemmt und mit einem Seilüberstand von 1 Meter versehen, können die Seile aufgrund des Pflanzenwachstums nachrutschen. Eine Beschädigung der Fassadenoberfläche kann dadurch vermieden werden und die auf die Wandhalter wirkenden Kräfte werden reduziert.

Ferner eignet sich das I-SYS Ranksystem für Begrünungen, die stark gegliedert sind und der Gebäudearchitektur angepasst werden sollen (Ausparungen für Fenster, Seilverlauf entsprechend der Fassadengeometrie).

The I-SYS greenery system is particularly appropriate for twining plants. By using the fork bracket, high strengths can be absorbed by the façade. If the cables are attached hand tight at the bottom wall holder, and with an overhang of 1 metre, the cables can set up autonomously with the growth of the plants. Thereby damage of the façade surface can be avoided and the possibility of shock loads at the wall holders will be reduced.

In addition, the I-SYS greenery system is appropriate for greeneries which are highly structured and need to be adapted to the specific architecture of a building (e.g. openings for windows, run of the cables to suit to the geometry of the façade).

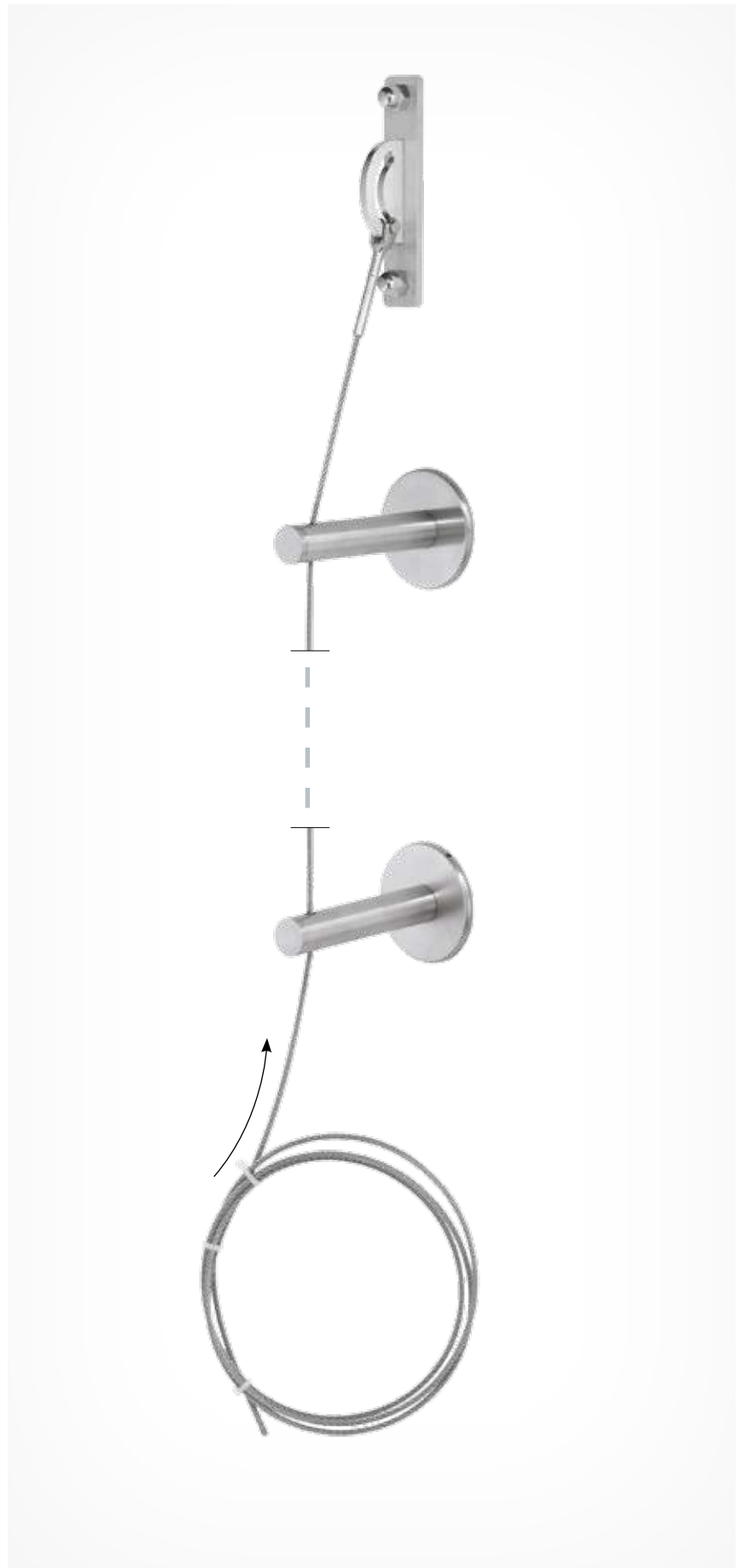

PLANUNGSHILFEN_PLANING ASSISTANCE

Pflanzenart ¹ Type of Plants ¹	Pflanzenbeispiel Examples of plants	Konstruktion Construction	Raster Grid size		Wand- abstand Distance to wall mm	Wuchshöhe Growing height m	Pflanzen- gewicht ³ Weight of plants ³ kN/m ²
			Höhe, mm Height, mm	Breite, mm Width, mm			
Schlinger/Winder ² Vines (twining plants) ²	<ul style="list-style-type: none"> – Wisteria ... – Lonicera ... – Fallopia ... – Actinidia ... 	Vertikale Seile Vertical cables	–	400-1500	80-160	3-30	0,10-0,26
		Gitterförmig Grating	400-600	400-1500			
Blatt- und Blattstielranker Leaf- and leaf-stem climbers	<ul style="list-style-type: none"> – Clematis ... – Tropaeolum ... 	Gitterförmig Grating	400-600	400-1500	50-120	3-10	0,03-0,12
Spreizklimmer Scrambling plants	<ul style="list-style-type: none"> – Jasminum ... – Rosa ... – Rubus ... 	Horizontale Seile Horizontal cables	–	400-1500	50-120	2-8	0,06-0,12
		Gitterförmig Grating	400-600	400-1500			
Sprossranker Spear climber	<ul style="list-style-type: none"> – Vitis ... – Ampelopsis ... 	Gitterförmig Grating	400-600	400-1500	80-120	3-30	0,12-0,25

- 1 Wandkonstruktionen mit offenen Fugen oder dergleichen (z. B. hinterlüftete Fassaden) dürfen nicht mit lichtfliehenden Pflanzen begrünt werden, da diese in die Spalten eindringen und durch ihr Dickenwachstum Schäden verursachen können.
- 2 Bei leichten bis mittelstarken Schlingern/Windern ist ein spiralförmiges Umschlingen der Seile möglich. Bei starken Schlingern/Windern sollten die Pflanzen außen an den Seilen angebunden und geführt werden. Ein ausreichender Abstand zu anderen Baukonstruktionen (Fallrohre, Markisen, Vordächer, Brüstungsgeländer usw.) verhindert deren Beschädigung durch das Dickenwachstum der Schlinger/Winder. Bei senkrechten Seilen empfehlen wir die Verwendung von Klettersprossen im Abstand von max. 800 mm (zur Selbstmontage vor Ort).
- 3 Pflanzen durchnässt: Wert + ca. 25 %, Pflanzen vereist: Wert + ca. 80 % | kN = Bruchkraft.

- 1 Wall constructions with open gaps or similar (e.g. rear ventilated façades) must not be greened with plants averse to light as they will grow into the gaps and might cause damage due to the secondary growth. When choosing climbing plants their growing height to be considered with respect to the available height of the trellis.
- 2 Weak and moderate twining plants can wind spirally around the cables. Strong twining plants should be tied to the ropes to help route them. An adequate distance from other constructions (e.g. down-pipes, blinds, canopies, balustrades, etc) helps avoid damage due to the secondary growth of the twining plants. When using cables we recommend the use of climbing studs at distances of max. 800 mm.
- 3 Wet plants: factor + approx. 25 %, frosted plants: factor + approx. 80 % | kN = breaking load.

EDELSTAHL IN DER NAHAUFNAHME

A CLOSE-UP VIEW OF STAINLESS STEEL

Bereits bald nach ihrer Entwicklung wurden die nicht rostenden Stähle für dekorative und lastbeanspruchte Anwendungen im Bauwesen entdeckt. Edelstahl Rostfrei ist nicht nur optisch ansprechend, sondern macht Bauwerke besonders langlebig, wirtschaftlich und umweltfreundlich.

The suitability of stainless steels for decorative elements or in architectural applications where load stresses are the norm became evident very soon after they were first developed. Stainless steel not only has a high visual impact; it also makes structures more durable, more economical and more environmentally friendly.

BEZEICHNUNG, INTERNATIONALER VERGLEICH

DESIGNATIONS, INTERNATIONAL COMPARISON

- Austenitischer Stahl mit hohem Legierungsanteil der Werkstoffgruppe A4
- Legierungsbestandteile:
16,5–18,5 % Chrom, 10–13 % Nickel, 2 % Molybdän
- Austenitic steel with a high alloy content, material grade A4
- Alloy components:
16,5–18,5 % chromium, 10–13 % nickel, 2 % molybdenum

DIN 17440	1.4401	1.4404
DIN EN 10088-3	X5CrNiMo17-11-2	X2CrNiMo17-12-2
AISI	316	316L
UNS	S31600	S31603



TECHNISCHE EIGENSCHAFTEN

TECHNICAL CHARACTERISTICS

Elektrische Leitfähigkeit

- beschreibt man üblicherweise mit dem Kehrwert, dem spezifischen Widerstand. Die Topleiter (Kupfer oder Silber) leiten den elektrischen Strom knapp 40-mal besser als Edelstahl, aber im Vergleich zu einem Isolator wie Porzellan leitet Edelstahl den Strom eine Billion Mal besser.
Üblicher Wert bei 20 °C = 0,75 (Ωmm²)/m.

Electrical conductivity

- is usually described by means of the reciprocal value, the specific resistance. The very best conductors (copper and silver) conduct electricity almost 40 times better than stainless steel; compared to insulators like porcelain, however, stainless steel conducts current a billion times better.
Typical value at 20 °C = 0,75 (Ωmm²)/m.

Magnetismus

- Austenitische Stähle der Güteklasse A4 sind in der Regel nicht magnetisch. Bei größerer Kaltumformung, wie es bei der Herstellung kleinerer Seil- bzw. Drahtdurchmesser vorkommt, kann sich jedoch ein geringer Magnetismus wieder einstellen.
Üblicher Wert der Permeabilität $\mu_r \leq 1,3$.

Magnetism

- Grade A4 austenitic steels are not normally magnetic. However, they can become slightly magnetised as a result of intensive cold forming, for example when manufacturing small cable or wire diameters.
Typical permeability $\mu_r \leq 1,3$.

Wärmeleitfähigkeit

- Zwar leitet Edelstahl die Wärme 20-mal schlechter als Silber und Kupfer, aber nur 3,5-mal schlechter als normaler Stahl und 300-mal besser als sogenannte Wärmedämmstoffe!
Üblicher Wert 15 W/(m*K)
- Das Material ist Einsatzfähig bis ca. 600 °C, jedoch mit Abstrichen bei der Festigkeit in Abhängigkeit von der steigenden Temperatur.
- Edelstahl ist eingeordnet in der Brandschutzklasse A1 gemäß EN13501-1:2007

Wärmeausdehnungskoeffizient

- α (Längenänderungskoeffizient) für legierte Stähle = 0,000016
- Δl (Längenänderung in mm) = α (Längenänderungskoeffizient) x L1 (Seillänge in mm) x Δt (Temperaturunterschied)

Thermal conductivity

- Although silver and copper have 20 times better thermal conductivity than stainless steel, carbon steel is only 3.5 times better. Stainless steel has 300 times better thermal conductivity than so-called insulation products! Typical value 15 W/(m*K)
- The material can be used at any temperature up to approximately 600 °C, though its strength decreases as the temperature increases.
- Stainless steel is divided into the fire prevention class A1 according EN13501-1:2007

Coefficient of thermal expansion

- α (coefficient of linear thermal expansion) for alloy steels = 0.000016
- Δl (linear expansion in mm) = α (coefficient of linear thermal expansion) x L1 (cable length in mm) x Δt (temperature difference)

WANN KANN EDELSTAHL TROTZDEM ROSTEN? WHY DOES STAINLESS STEEL SOMETIMES RUST?

- Flugrost aus eisenhaltiger Atmosphäre (Bahnübergänge, Schleifstaub aus der Werkstatt oder Baustelle)
- Konstruktive Fehler (stehendes Gewässer, Verbindung mit anderen Materialien)
- Verarbeitungsfehler durch Nutzung von ungeeigneten Werkzeugen (Stahldrahtbürsten, Schleifscheiben, Stahlwolle oder Schweißzusätze)
- Verunreinigung auf Baustellen durch unsachgemäße Handhabung
- In Meeresnähe (A4 ist nicht meerwasserbeständig), jedoch abhängig vom tatsächlichen Chloridgehalt der Umgebungsluft
- In Hallenbädern, (A4 ist nicht chlorwasserbeständig)
- Flash rust due to iron oxide particles in the atmosphere (railway crossings, grinding dust in workshops or on site)
- Defects in design (stagnant water, combination with other materials)
- Defects in workmanship owing to the use of unsuitable materials (steel wire brushes, grinding wheels, steel wool or weld fillers)
- Contamination on site caused by improper handling
- In coastal areas (A4 is not seawater resistant); however, depending on the actual chloride content in the ambient atmosphere
- In indoor swimming pools (A4 is not resistant to chloridic water)

GEGENMASSNAHMEN UND REINIGUNGSEMPFEHLUNGEN HOW TO AVOID CORROSION/CLEANING RECOMMENDATIONS

- Saubere Verpackung, vor allem beim Transport auf den Baustellen
- Kürzere Reinigungsintervalle
- Entfernung von grobem Schmutz durch Hochdruckwasserstrahl
- Handelsübliche Edelstahlreiniger, Azeton oder Spiritus
- Weiche Reinigungstücher oder spezielles Edstahlvlies
- KEINE Salzsäure oder salzsäurehaltigen Lösungen, KEINE chlorid- oder fluoridhaltigen Reiniger!
- Clean packaging, especially on construction sites
- Short cleaning intervals
- High-pressure water jet to remove coarse dirt
- Commercial stainless steel cleaners, acetone or ethanol
- Soft cleaning cloths or special stainless steel fibre
- NEVER use hydrochloric acid or cleaning solutions containing hydrochloric acid, chloride or fluoride!

KONFEKTIONS LÄNGEN

ASSEMBLY LENGTH

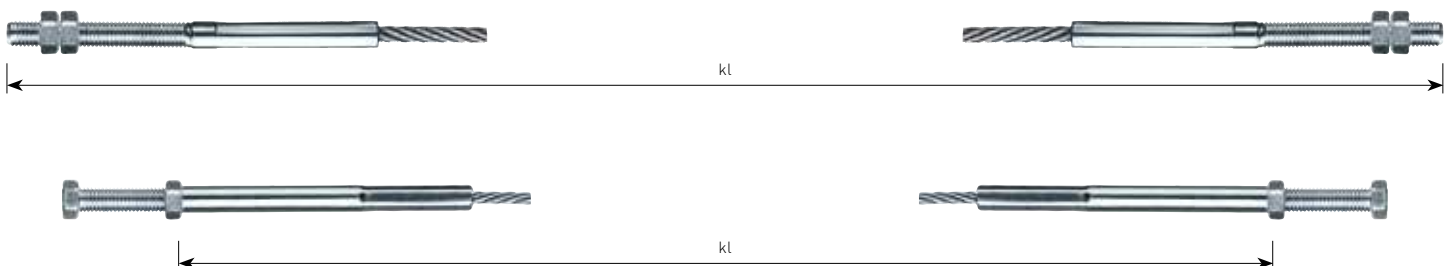
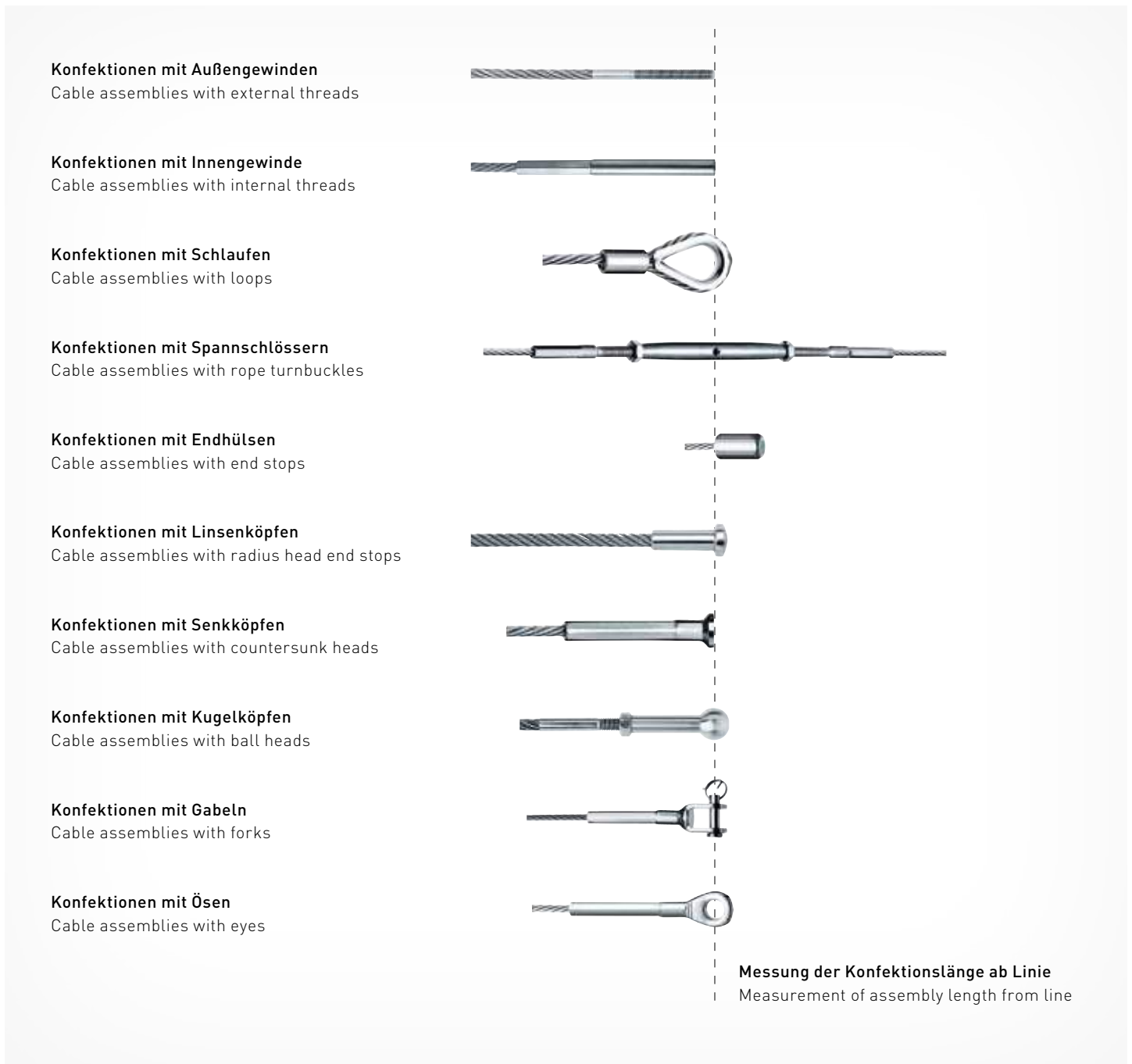

BROSCHÜREN IM ÜBERBLICK

BROCHURES AT A GLANCE

PRODUKTE_PRODUCTS



X-TEND



I-SYS



POSILOCK



TENNECT



GREENCABLE



X-LED



ETA X-TEND



ETA I-SYS

REFERENZEN_REFERENCES



SICHERUNGEN
SAFETY

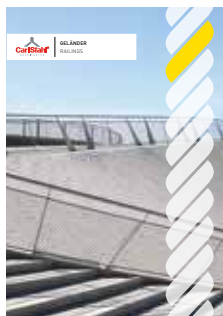

GELÄNDER
RAILINGS



SEIL-SYSTEME
WIRE ROPE SYSTEMS

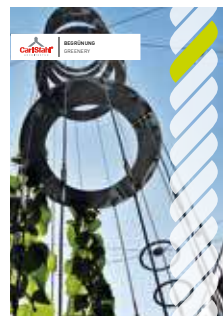

BEGRÜNUNG
GREENERY



FASSADE
FACADE



GESTALTUNG
DESIGN



ZOO-ANLAGEN
ZOOLUTIONS



carlstahl-architektur.com

Ihr Kontakt_Your contact

